

ThermalTronix

TT-ET2W-HTI

User Manual

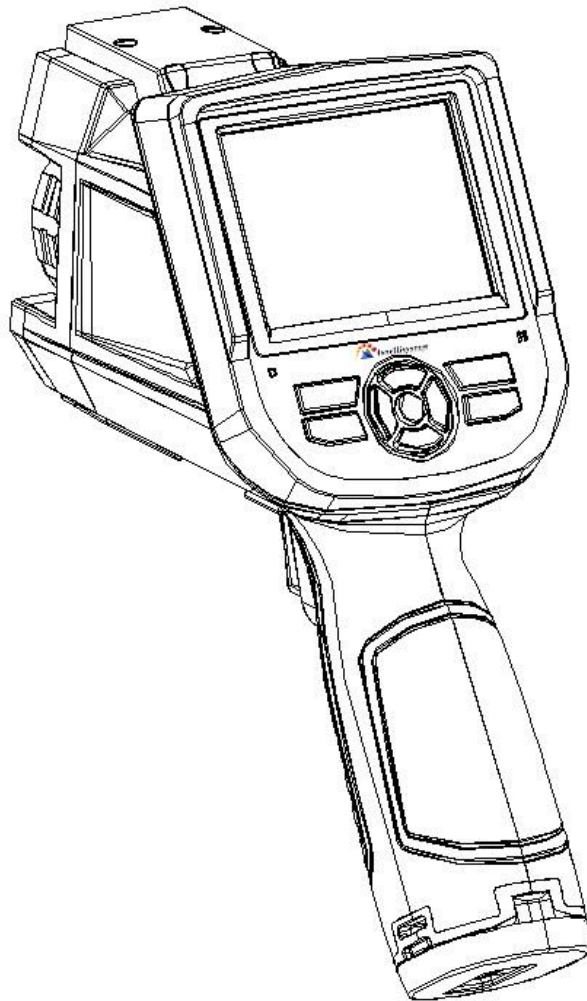

! Warnings, Cautions and Notes

Definitions

- ! **WARNING** Could cause bodily injury or death.
- ! **CAUTION** Could cause damage to equipment or permanent loss of data.
- ! **NOTE** provides useful information to the operator.

Important Information – Read before using the Instrument

- ! **WARNING** – Laser Radiation is emitted from this device. **Do Not** stare into Laser Beam. **Class 2 Laser, 635 nm, 0.9mW**
- ! **CAUTION** - Never point the lens directly toward a strong radiation source (ie. Sun, direct or reflected laser beam, etc), with power on or power off, as damage may result to the thermal detector used inside. **Permanent damage may result!**
- ! **CAUTION** - The original shipping carton should be kept for use for future transportation. Do not drop, shake or impact the thermal imager excessively, in use or during transportation.
- ! **CAUTION** - Store the unit in its original case in a cool, dry, well-ventilated area away from strong electromagnetic fields.
- ! **CAUTION** - Protect the surface of the lens from being stained or damaged by foreign objects such as sludge or chemicals. Please replace the lens cap after use.
- ! **CAUTION** - Please remember to backup image data regularly to avoid losing important data.
- ! **NOTE** - For maximum measurement accuracy, allow 3 to 5 minutes for camera to stabilize after initial power up.

- ! **NOTE** - Each camera is factory calibrated. It is recommended that calibration be performed every 12 months.
- ! **CAUTION** - Do not open case. Unit does not contain any user serviceable parts. Repair should be performed by factory authorized technicians only.

Contents

! Warnings, Cautions and Notes.....	1
1 Introduction	5
• 2 lines measurements.....	5
1.1 Standard accessories	7
1.2 Optional accessories.....	7
2 Camera overview	8
2.1 Function keys.....	8
2.2 Interface.....	12
3 Basic operations	13
3.1 Battery Installation and Replacement	13
3.1.1 Inserting or removing battery	13
3.1.2 Replacing battery.....	14
3.2 Battery safety and usage	15
3.3 Quick access.....	16
3.3.1 Capture an image.....	16
3.3.2 Temperature Measurement.....	16
3.3.3 Save Image.....	17
3.3.4 Playback Image.....	17
3.3.5 Download the Save Files.....	18
3.3.6 Screen Setting	18
3.3.7 Manu Operation Introduction	18
4 Operation guide	19
4.1 Graphic interface description	19
4.1.1 Screen graphic interface	19
4.1.2 Floating Bar Interface	20
4.1.3 Main Menu	21
4.1.4 Sub-menu interface.....	21
4.2 Measurement Object Adding.....	22
4.3 Recording.....	23
4.4 Photo	23
4.5 Preview	24
4.6 Setting	24
4.6.1 Measuring setting	28
4.6.2 Adjustment.....	29

4.6.3	Image Setting	30
4.6.4	Network setup.....	33
4.6.5	TF Card Management.....	34
4.6.6	Photo Setting.....	36
4.6.7	System Setting	37
4.7	File Management.....	40
4.7.1	Playback.....	40
4.7.2	Bluetooth Transmission	43
4.7.3	Delete.....	44
5	Webpage operate.....	45
5.1	Webpage login	45
5.2	Surveillance image.....	45
5.3	Function operate	46
5.3.1	System parameter set	47
5.3.2	Photo Setting.....	48
5.3.3	Graphic setting	48
5.3.4	Measurement Setting.....	49
5.3.5	Network.....	49
5.3.6	Local Settings.....	50
5.3.7	System Maintenance	50
6	Configuration.....	52
7	Troubleshooting.....	54

1 Introduction

Thank you for choosing Instruments "TT-ET2W-HTI" hand-held infrared thermal imager.

Model Identification

TT-ET2W-HTI imagers use the detector with 25um 384*288, and measurement range from +30°C~+42°C

Features

- TT-ET2W-HTI includes the following features:
- 11 user selectable color palettes
- 11 user selectable languages
- 2X , 4X digital zoom
- 5 removable spot measurements
- 5 Areas measurements
- 2 lines measurements
- Custom shortcuts
- Blue tooth
- Power saving mode
- LCD Brightness adjustment
- Video Output – NTSC or PAL
- Internet settings
- Time and Date settings
- Factory settings restore
- TF card uninstall, formatting
- TF card image storage, video storage
- Text and Audio annotation via image storage
- Consecutive image shot storage

- Alarm image capture
- Alarm video record
- Isotherm measurement function
- Temperature measurement settings
- Built in Emissivity Table list of common materials
- CMOS visible image and storage
- Infrared and visible image fusion
- Merge set

Applications:

Preventive maintenance

- Power industry: Power line and power facility thermal state checking; problem and defect diagnosis.

- Electrical system: Identify potential circuit overloads.
- Mechanical system: Reduce downtime and avoid catastrophic failure.

Construction science

- Roof: Quick identification of water penetration problems.
- Structure: Commercial and residential energy audits.
- Moisture detection: Determine root cause of moisture and mildew.
- Evaluation: Evaluate the resolution to ensure the area completely dry.

Others

- Iron and steel industry: Inspect steel refining and rolling processes; diagnose hot-blast stove defects; detect the embryo temperature of armor plate, etc.

- Fire fighting: Forest fire prevention and detection of latent ignition source. Preventive detection on specific materials of auto-ignition. Detection of potential spark ignition sources.

- Medical: Human body surface temperature detection and screening.

- Petro/chemical: Oil pipeline status inspection; material surface temperature detection; insulation inspection; power equipment status, etc.

1.1 Standard accessories

- Infrared thermal image camera (with wrist strap)
- Carrying case
- Video out cable
- Lithium ion batteries
- User manual, Infrared report and analysis software system CD
- Lithium battery charger
- Lens cap
- TF card
- TF card reader
- USB cable
- Black body

1.2 Optional accessories

- External 0.5x wide-angle lens
- External 2x telescopic lens
- Eye patch
- Power adapter (with power cable and plug)
- European standard plug
- British standard plug
- Australian standard plug

2 Camera overview

2.1 Function keys

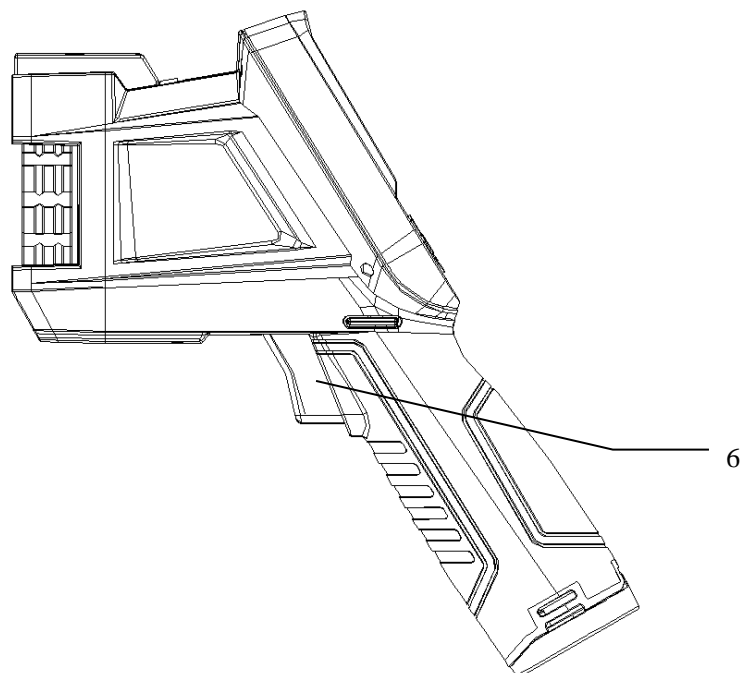
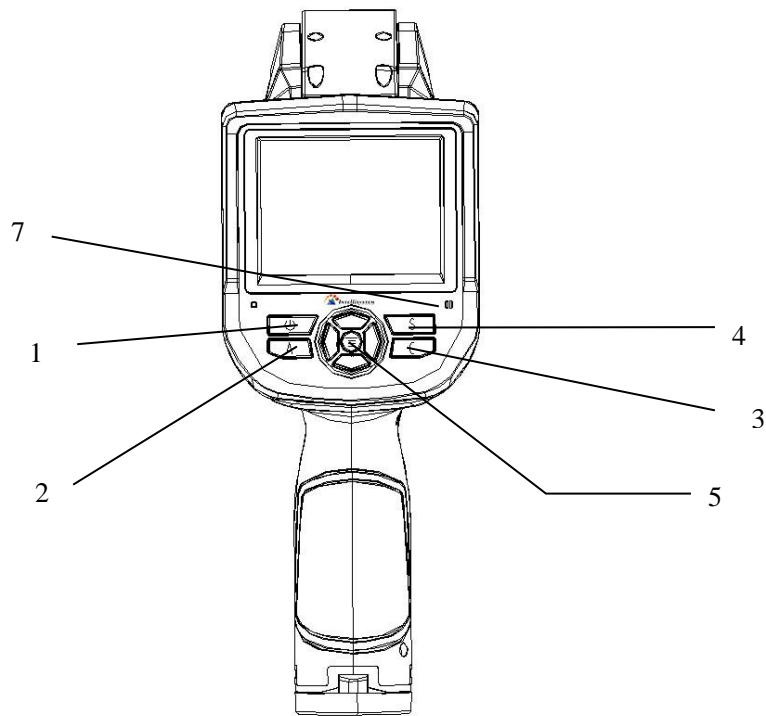

[1] Power key

Press and hold the Power Key for > 3 seconds to power on/off the camera.

! Note: After powering off, please wait ten seconds before powering the camera on again.

[2] Select/Auto key (Marked "A")

The "A" or attribute button performs 2 functions.

a) The first function is modification of selected parameters. It is obtained by a quick press and release (less than 2 seconds), with this functions to modify their parameters. Subsequent presses will "scroll" through the available parameters. The selected function will be highlighted in yellow. The functions include:

- **Measurement points, areas, and lines**

Points, areas, lines – switching the added points, areas and lines in the interface from Up to Down, press Menu to set properties, press C to delete the Selected measuring objects.

- **Color Palette**

Pressing the left or right arrows will scroll through the available color palettes, displaying their name above the palette. The selected palette will become active after about 3 seconds of selecting it and will be set as the default power on palette.

- **Level/Span values**

Pressing the left or right arrow will reduce or increase the Span and pressing the up or down arrow will reduce or increase the Level. If the unit is in Automatic mode, modifying any of these parameters will select Manual mode.

b) The second function performed is to force an internal calibration cycle. This is performed by pressing and holding the **A** key for 5 seconds or more. The camera will make automatic correction to get the most accurate thermal

measurement.

c) Image transmission via blue tooth. Open blue-tooth, select object image, short press **A**, it will display sending dialog.

[3] Cancel/Camera key (Marked "C")

- Pressing and releasing the **C** key cancels the present operation when in **Menu** mode.
- Pressing and releasing the **C** key when an image is frozen or being viewed from memory, will return to real-time measurement status.
- When not in menu mode or parameter editing, pressing and releasing the **C** key will toggle between the thermal image and the visible CCD camera image.
- When a parameter is selected, such as a measurement cursor, pressing the **C** key will delete the highlighted measurement.

[4] Freeze/Save key (Marked "S")

Used for freezing or saving thermal image. Press the key once to freeze the image. Press Confirm to save the image or Press C to return to real-time measurement. If Audio recording is enabled, Audio comment dialog box will display. In document management, press S to delete video or image.

[5] Menu/Confirm key (bar)

Includes **Up**, **Down**, **Left**, **Right** and **Menu/Confirm** (center) keys. Function varies with operation mode.

In **Menu mode**, it is used for menu selection. **Up** and **Down** keys are for same level of menu operation. **Left** and **Right** keys are for different levels menu operation. **Confirm** key (center) is to activate the menu and confirm the choice.

In **Image mode**, press **Up** or **Down** key to activate X2 digital zoom. The screen will display "X2" in the upper left corner. Press **Up** or **Down** key to return to the original image.

In **Spot Measurement** editing mode (activated immediately after adding a spot or by selecting via the **A** key), press the **Menu** key to pop up the attribute box. Press four navigation keys to move the spot location.

In line temperature measurement editing mode (activated immediately after adding a line or by selecting via the **A** key), press the **Menu** key to pop up the attribute box. If measurement line is horizontal, press **Up** and **Down** keys to move the line location, press **Left** and **Right** keys to move the reference line. If measurement line is vertical, press **Left** and **Right** keys to move the line; press **Up** and **Down** keys to move the reference line.

In area measurement editing mode (activated immediately after adding an area or by selecting via the **A** key), press the **Confirm** key to pop up the attribute box. Select in the attribute box the parameter to be edited, either size or position. Press the four navigation keys to move the area location or change the size of the area.

[6] Trigger/Shortcut key

The trigger key serves as a shortcut to access the following functions:

Laser – Pulling trigger activates laser sight and releasing deactivates it.

Spot, Area– Pulling and releasing trigger adds a spot or area. Pulling and releasing trigger again removes the spot or area.

Video and Image Save –pressing to initiate a Save cycle.

Zoom pressing to zoom the infrared image

LCD brightness adjustment pressing to activate

[7] Microphone

Used for recording a voice message with the Saved image

2.2 Interface

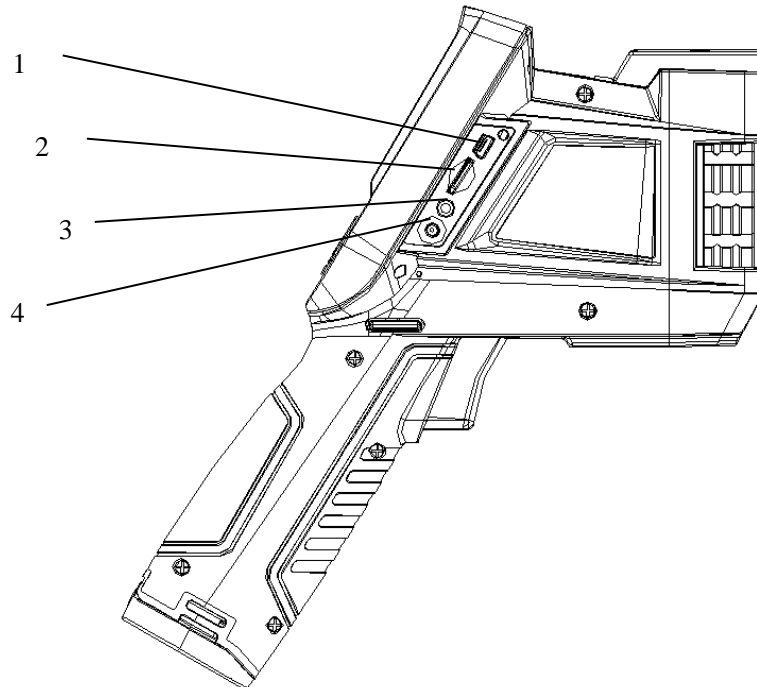

[1] USB to RJ45 output

Used for internet connecting.

[2] TF Card slot

Accepting standard size TF card such as supplied 8GB capacity card, for device upgrade or image storage.

[3] Video port

It is a video output interface.

[4] Power interface

External power input interface. Power source should be +12VDC. Center pin is positive terminal.

3 Basic operations

3.1 Battery Installation and Replacement

3.1.1 Inserting or removing battery

Battery compartment is located inside the handle. Turn the cover counter-clockwise to remove. Remove battery for replacement.

13

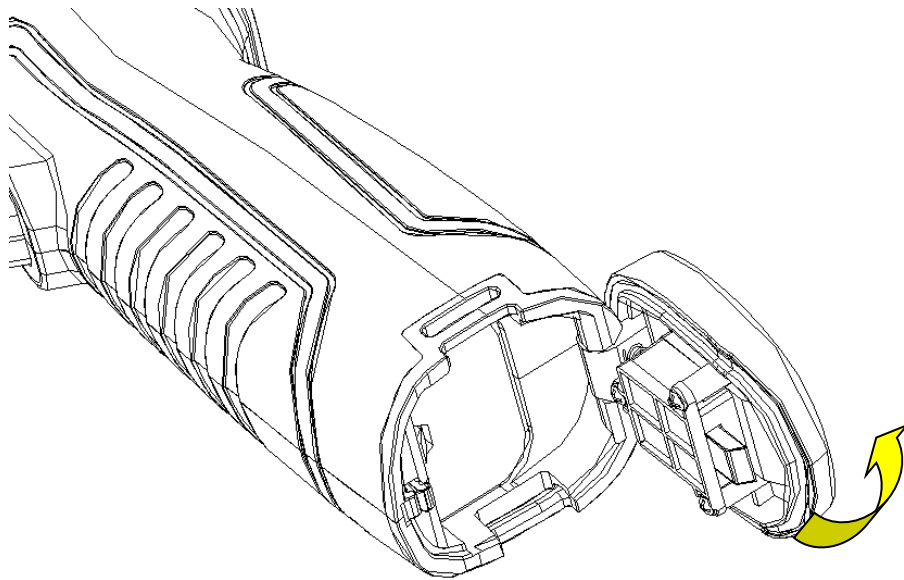

Insert the battery (the battery contacts must face into the battery compartment).

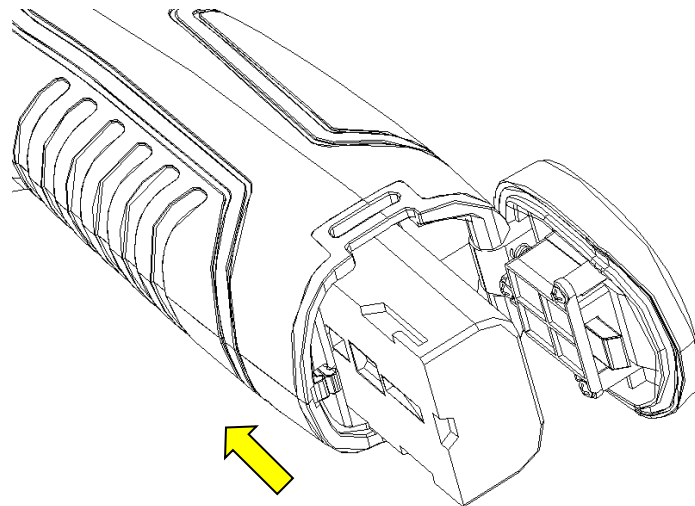

Replace the cover and screw down.

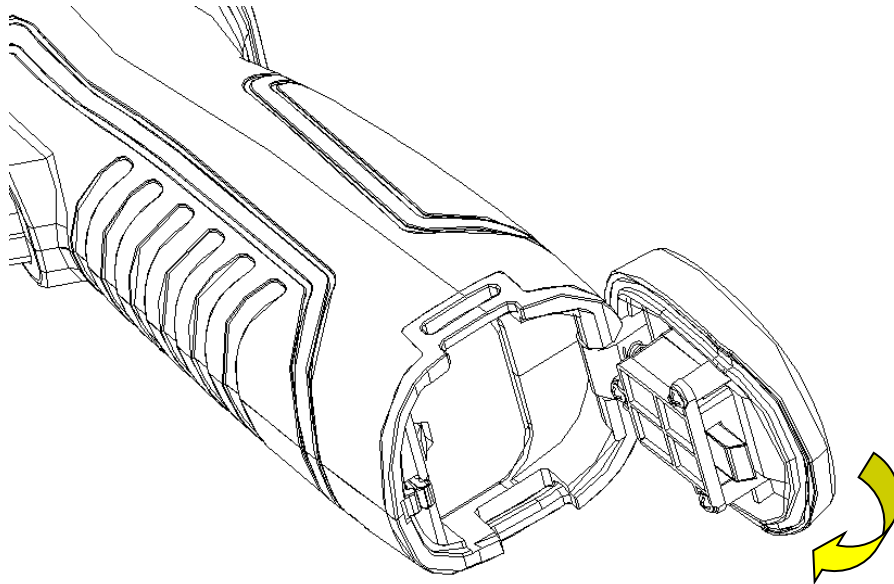

! CAUTION: Use only original manufacturer replacement battery. Use of incorrect battery may result in physical or electrical damage to the instrument due to incorrect voltage or physical size difference.

3.1.2 Replacing battery

When battery displays empty and flashes for about 1 minute and 50 seconds, the instrument displays a low battery dialog and shut down automatically after about 10 seconds.

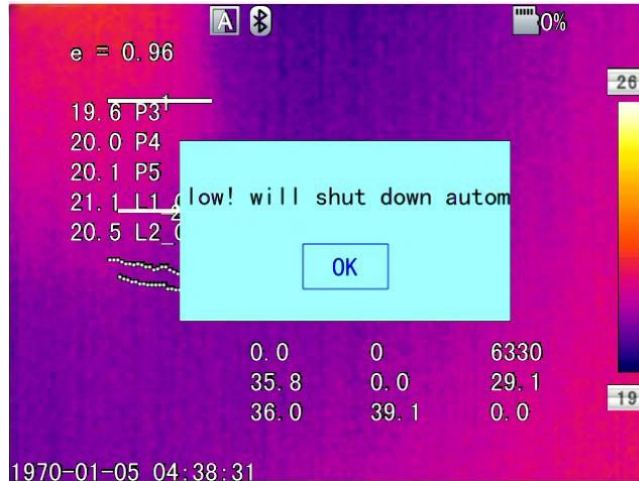

Powering off display

It's better to replace batteries now.

3.2 Battery safety and usage

- Batteries should be stored in an ambient temperature of -4°F (-20°C) to 67.9°F ($+20^{\circ}\text{C}$). Lithium batteries will self-discharge during storage, so they should be fully charged before storage. Self-discharge may affect long term battery performance. Furthermore, it is recommended that the battery should be charged in a set time, as below; Ambient temperature of:
 - -4°F (-20°C) to 67.9°F ($+20^{\circ}\text{C}$), once every 6 months
 - 67.9°F ($+20^{\circ}\text{C}$) to 113°F ($+45^{\circ}\text{C}$), once every 3 months
 - 113°F ($+45^{\circ}\text{C}$) to 149°F ($+60^{\circ}\text{C}$), once every month
- Battery should have greater than 50% charge prior to recharge.
- The ambient temperature for charging should be 32°F (0°C) to 104°F ($+40^{\circ}\text{C}$). If under 32°F (0°C), the battery capacity will be diminished; if over 104°F ($+40^{\circ}\text{C}$), the battery may overheat, resulting in permanent damage.

! WARNING:

- ! Never disassemble, incinerate or puncture battery
- ! Never short circuit the battery
- ! Keep battery dry
- ! Keep out of reach of children
- ! Always dispose of battery in accordance with local, state and federal regulations

3.3 Quick access

3.3.1 Capture an image

- Witch on the black body, set the blackbody temperature at 37°C
- After installing the battery, press and hold the power key (≥ 3 seconds) until the display comes on. After approximately 50 seconds, the power on routine will finish and the camera will start its measurements.
- Press button "C" to switch the display image into thermal mode
- Remove the lens cap, point the camera at the blackbody, and adjust the focus manually until get clear image.

! Note: Focus is not clear, and will lead to measurement error.

- Press button "A" to auto calibrate to get the best image.
- Press "C" button for two times to switch the display image into fusion mode. Press the navigation button "right" to adjust the degrees of fusion. Normally set the parameter to display 100% of the CCD image.

3.3.2 Temperature Measurement

- Let the target move to the cross point, the number shown at the up right corner is the temperature of the cross point. If you want more accuracy measurement, you can measure after pressing the button "A" for 3 seconds
- Switch the imager into fusion mode, Point the thermal imager at the blackbody which is about 2 meters far away, press the navigation button "down" , display "Base point Calibrate" menu as shown in the bellowing picture. Press "Menu/Confirm" button (select the "calibration" option) when the cross pointing at the center of the blackbody to finish the temperature calibration.

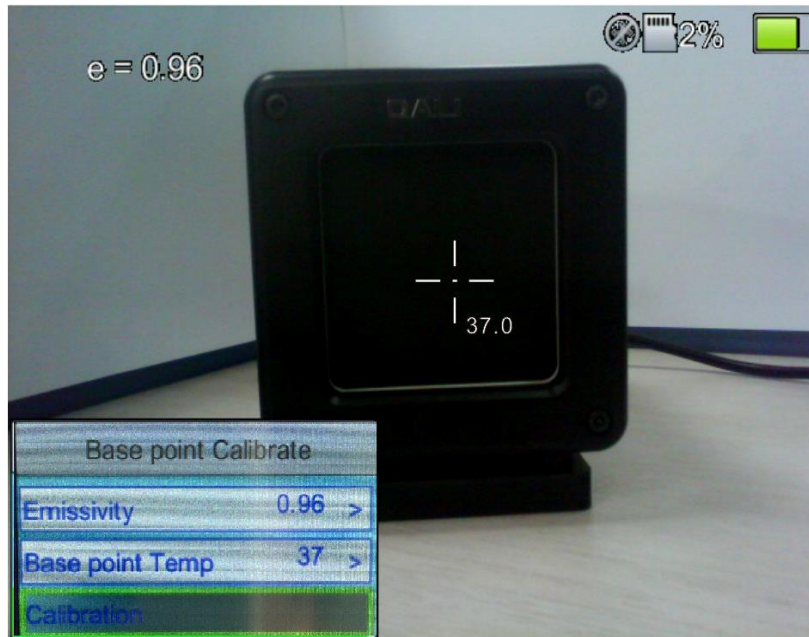

3.3.3 Save Image

Obtain the current image to store, you can choose one of the following four ways:

- Press Ok button and will show panel menu, select the "photo" option in the menu, the system will automatically save images
- Press S key, the image will froze, and press the same key again and the image will be saved.
- Keep press S key for 3 second, the image will be automatically saved.
- To set a shortcut key as Take Photo, then just need press this key to save image.

3.3.4 Playback Image

- Two way to open the image file:
 - 1、 Press the Ok key to activate the main menu, select "File Manager" menu , then select the submenu (via the arrow keys to select)
 - 2、 Click the "Preview" option in the floating panel to open the selected file (via the left and right keys to switch selection)
- After you open the image, you could use upper and lower sections of the playback control panel keys to playback the current store images.
- Press Cancel key to exit and return to the current state.

3.3.5 Download the Save Files



Can use card reader to download, delete, format the TF files.

! Note : Use the recommended form to format the TF card.

3.3.6 Screen Setting

There's two ways to set up: 1) Via general setup menu of "LCD brightness adjustment" to do screen brightness settings, so as to achieve the best effect. 2) By setting shortcut keys for the "LCD brightness adjustment", then use the shortcut key to adjust the LCD screen brightness.

3.3.7 Menu Operation Introduction

- Keyboard operation: press the "OK" button to pop up the floating panel, use left and right arrow keys on the floating panels to select the icon, click "OK" key to enter the relevant interface.
- Main menu interface: via "up and down" key to select the menu icon, click "OK" key to enter the submenu.
- Sub-menu interface: via "up and down" key to select, if there's the ">" mark, using right-click to enter the lower menu
- Parameter interface: The "up and down" key is to modify, the "left and right" key is to choose
- < > means modify the setting of the current menu.
- Press the "OK" button to confirm the changes, save and return to the previous menu, press the "C" key to cancel the changes and return to the previous menu.
-  Cancel and return to the previous menu button;  Save and return to the previous menu button. (For touch screen)
-  Switch button, by the left and right keys to modify the switch settings

4 Operation guide

4.1 Graphic interface description

4.1.1 Screen graphic interface

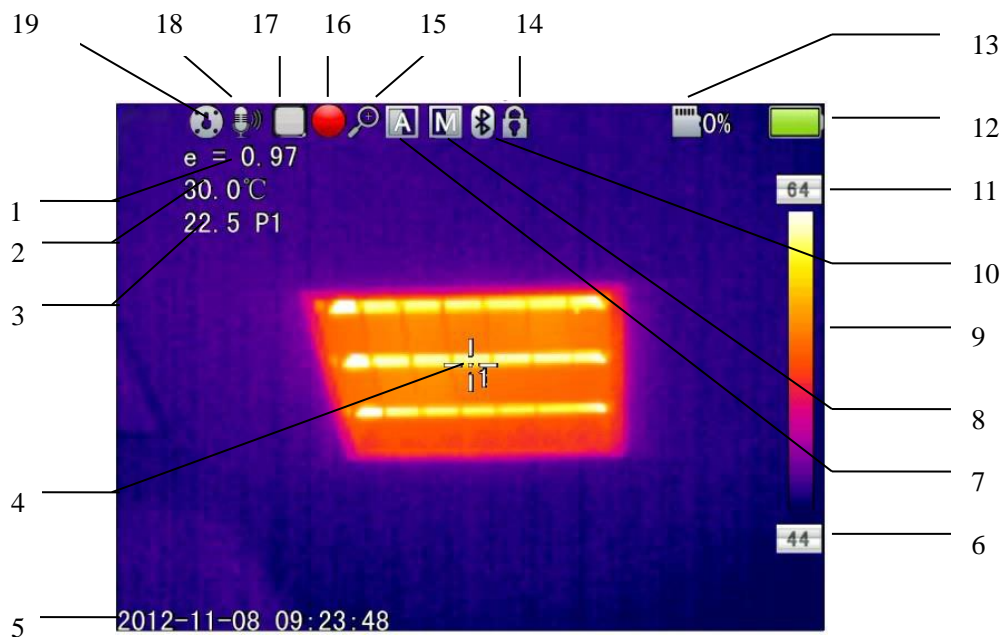

- [1] **Emissivity:** the current emissivity setting
- [2] **Reference Temperature:** fixed reference temperature
- [3] **Result:** indicates the temperature value of the target object. Black and yellow denotes the temperature value of the selected object.
- [4] **Spot temperature measurement:** white crosshair
- [5] **System:** the current system time
- [6] **Min temperature:** indicate minimum value of the palette
- [7] **Auto Enhancement:** select auto enhancement mode
- [8] **Manual Enhancement:** select manual enhancement mode
- [9] **Palette:** palette bar. User can choose different palettes

- [10] **Bluetooth:** select Bluetooth function
- [11] **Max temperature:** indicate the max value of the palette
- [12] **Battery status:** indicate the current battery status
- [13] **TF card:** indicate the TF card load status
- [14] **Freeze logo:** indicate the current image is frozen
- [15] **Zoom:** indicate the image is zoomed
- [16] **Recording:** indicate the recording status
- [17] **Continuous snap-shot:** indicate the continuous snap-shot status
- [18] **Voice recording:** indicate the voice recording status
- [19] **Calibration:** indicate the calibration status

! NOTE: Not all models have all functions, so the working status screen may not show all features.

4.1.2 Floating Bar Interface

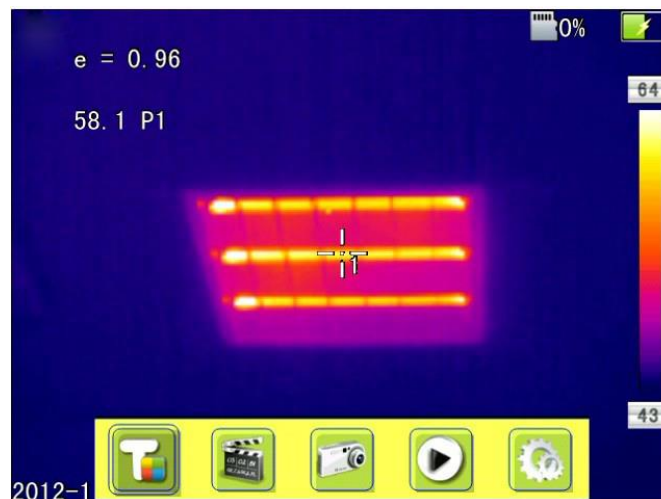

Floating bar interface

Floating bar interface : From left to right is namely the temperature measurement, video, photo, preview and settings menu.

4.1.3 Main Menu



Main Menu

The main menu items: display the main menu item, namely the document management, temperature settings, image settings, camera settings, general settings, network settings, TF card management and system setting.

4.1.4 Sub-menu interface

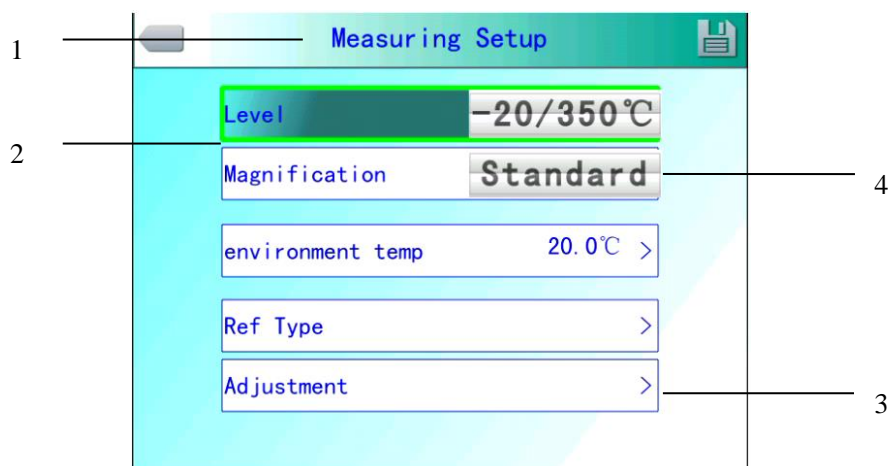

Sub-menu interface

[1] Figure name: Displays the name of the dialog box. The name of the dialog box as shown in the example is "temperature measurement setting."

[2] **Item title:** A dialog box may contain more than one item. As shown in the above figure

[3] **Item Content:** each item corresponds to the content of a project, the left and right keys to make changes, ">" indicates the lower menu.

[4] **Parameter options:** press the left button to select a different parameter.

4.2 Measurement Object Adding

This feature is used to increase or clear the measuring object. The following dialog box pops up, press the Enter key, floating menu pops up, select the temperature measurement target to add and press the Enter key.

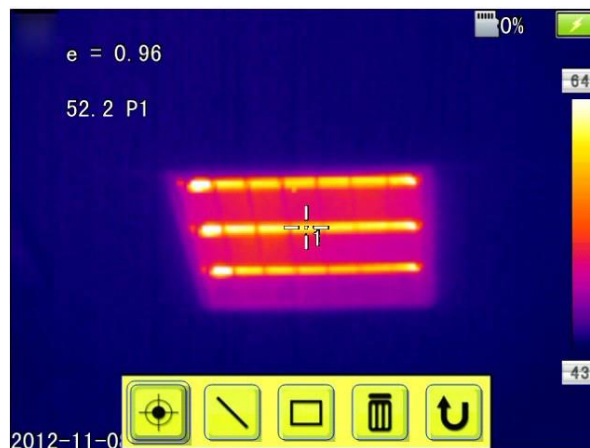

Temperature Measurement Object Adding Menu

If select "  ", then press OK key, then the all the objects will be cleared.

! NOTE: When you delete a single temperature measurement object, directly press "A" key and choose the object, then press the "C" key to delete.

4.3 Recording

This function is used to save the video, save format to MP4. Pressing the Enter key, floating menu pops up, select video and press the Enter key, as shown below.

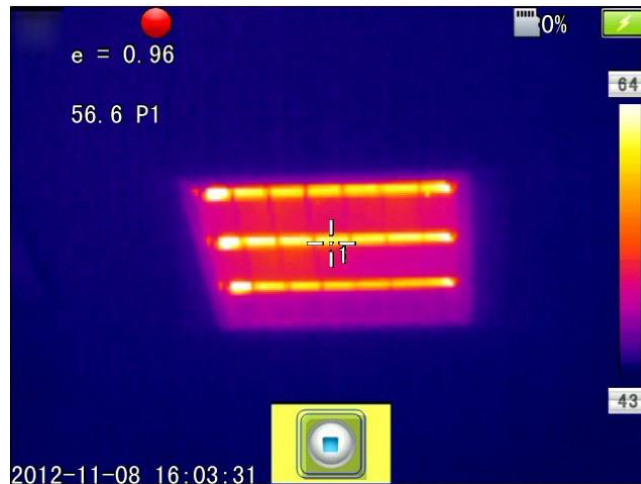

Recording Figure

Press stop key to end the recording, and return to the current operation status

4.4 Photo

This item is for photo. And back up in the JPG format. Pop up the floating menu after pressing confirming key. Then finish the photo. If turn up function of mark. Backup note will pop up in the OSD as followed.



Voice record note for photo

Continuous photos mark will appears in the status column if set the continuous photo

4.5 Preview

This item is for the preview files of backup. Press confirming key. Pop up the floating items , select preview and press confirming key will appears as followed.

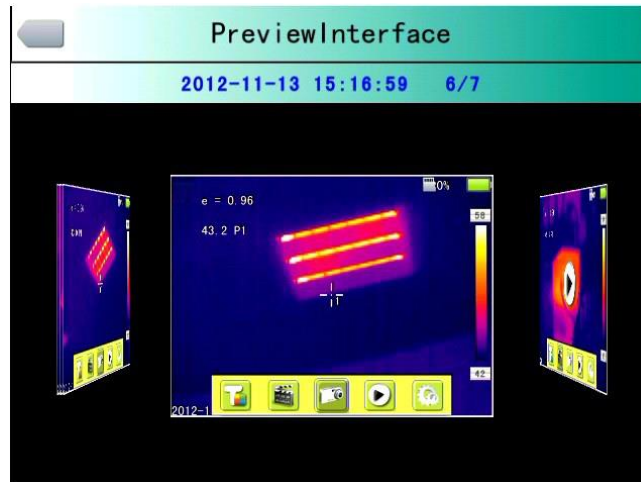

Preview OSD

Switch to files by pressing key of left or right. Open it and it appears in the screen by pressing confirming key. Press C key to quit

4.6 Setting



Main OSD

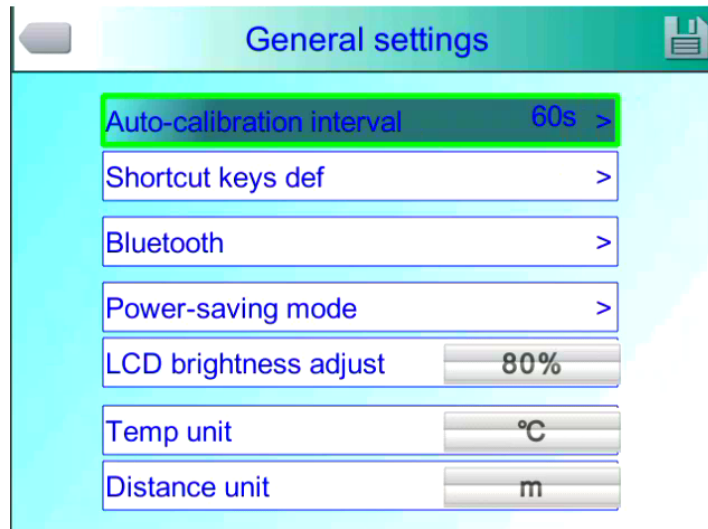

Normal setting OSD

Press confirming key will pop up the panel and select the SETTING to open the main menu. Select the Normal setting in the main menu. Normal setting OSD will pop up after pressing confirming key. Users could set the time of auto calibration / definition of shortcut key /Bluetooth/pattern of power saving/ brightness adjustment of LCD / unit of temperature / unit of distance .totally 7 items. Switch to items by pressing key of up or down. Change the value by pressing key of left or right. ">" means secondary -menu and enter the menu by pressing key of right.

Time of Auto calibration: Set time interval of auto calibration to get better thermal image and improve the precision. The unit is second

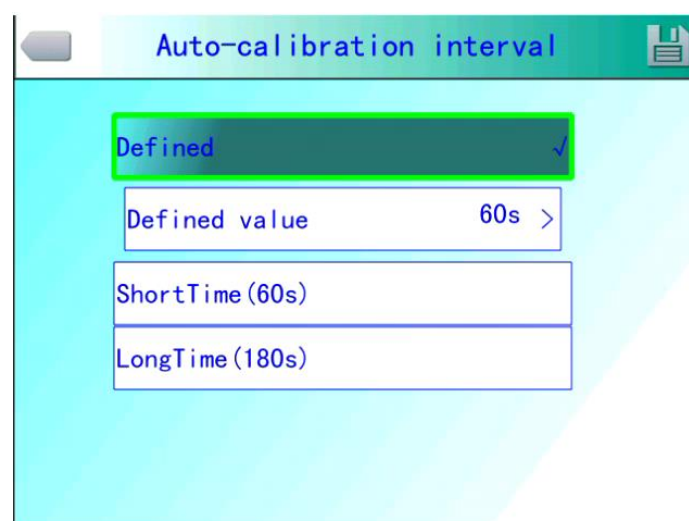

Auto calibration OSD

Shortcut key : Users could set the Functions of shortcut key. System offers record .screenshot. Enlargement. Reduction. Enlarge brightness of LCD. Reduce brightness. of LCD Laser. Lightness. Adding or removing spot 1 of testing temperature. Adding or removing area 1 of testing temperature and so on. When select shortcut key of laser. It will open the aimer of laser. Then it closes. When select shortcut key of light. It will open the lighting. Then it closes. When select shortcut key of spot 1. It will add or remove the spot 1. When select shortcut key of area 1. It will add or remove the area 1. When select shortcut key of record. It starts to record. When select shortcut key of photo. It starts to save the photos you took.

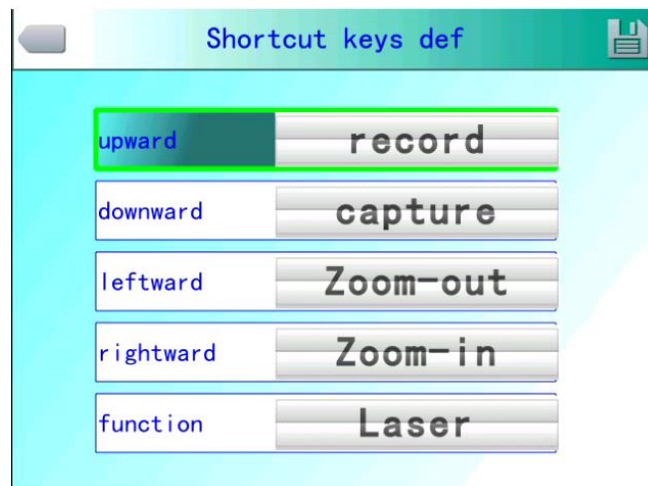

Shortcut key setting

Bluetooth : Turn on the Bluetooth will enable status of scanning and searching below, Turn off Bluetooth the status is not valid. Select scan and search key and start to scan the Bluetooth device .the model and the name of devices will show in the OSD .Enable status of Bluetooth the device will scan and search one time automatically.



Bluetooth OSD

Power saving : Screen off and power off

Time of scree off : If without any operation , thermal-imaging camera will screen off to save power。 Press any key except the power key, thermal-imaging camera will screen on 。 This function is not valid when time is set to 00 minute.

Time of power off : If without any operation , thermal imaging camera will power off to save power。 This function is not valid when time is set to 00 minute.

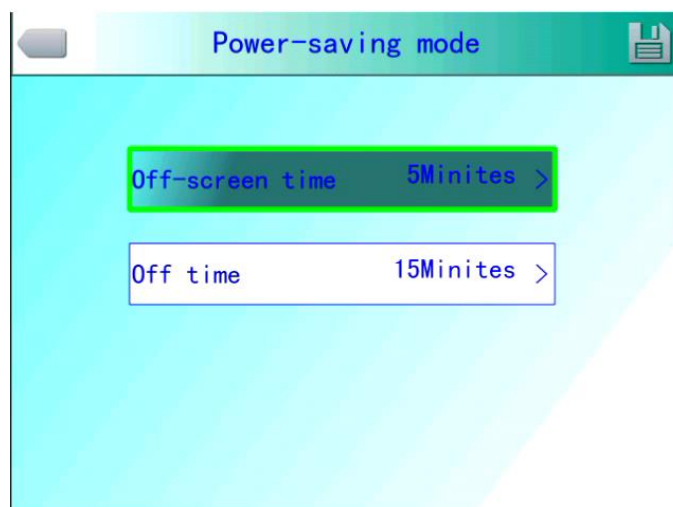

Power saving OSD

Intellisystem Technologies S.r.l.

LCD brightness adjustment : It is valid when changing the brightness.

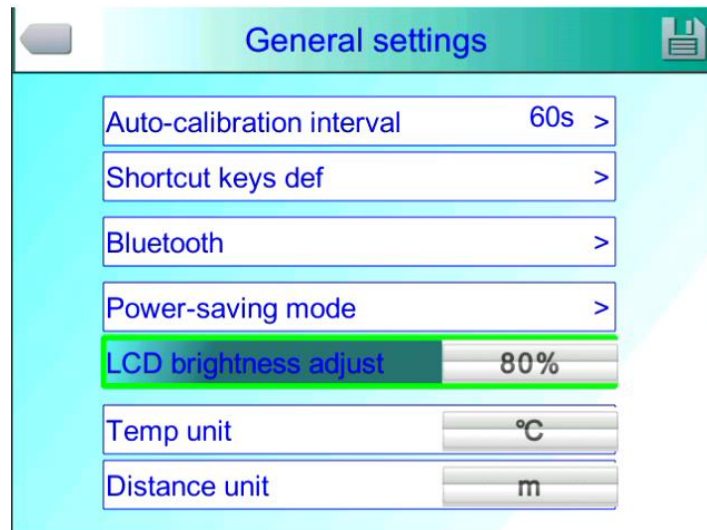

LCD brightness adjust OSD

4.6.1 Measuring setting

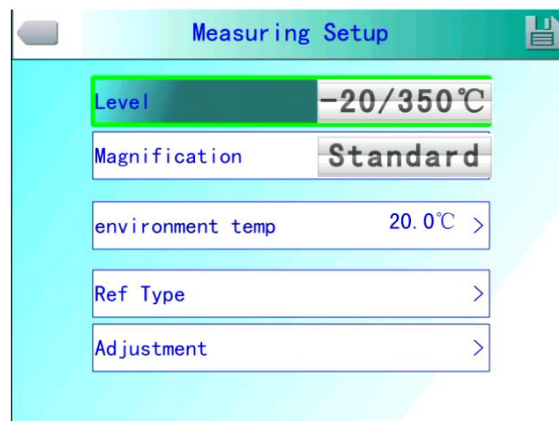

Measuring setting Menu

Press OK button to call out the Setting Menu. Select "Measuring Setting", and then press "OK" again to call out the setting interface. In this interface, Level, magnification, Environment Temp, Ref Temp can be set. Use UP &Down button to select," >" means there is sub menu, press Right Button to enter the sub menu.

Level: Setting the Measuring Level of the thermal camera.

Magnification: Setting the Magnification and the different Temp range.

Environment Temp: It will automatically detect the Environment Temp after the camera start-up.

Ref Temp: When it is enabled, the target temperature shown on the LCD is the D-Value between the real temp and the Ref-Temp.

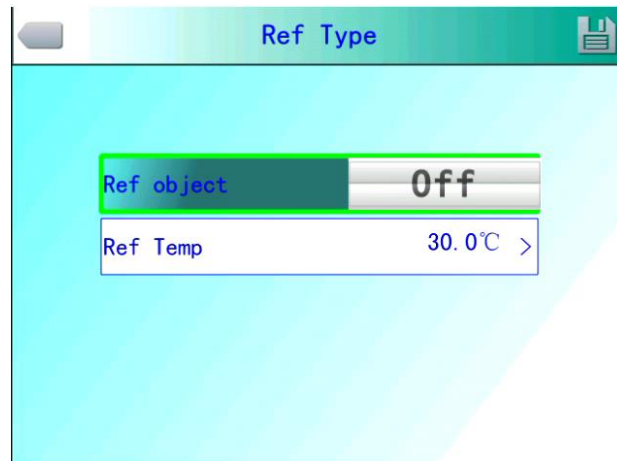

Ref Temp Menu

4.6.2 Adjustment

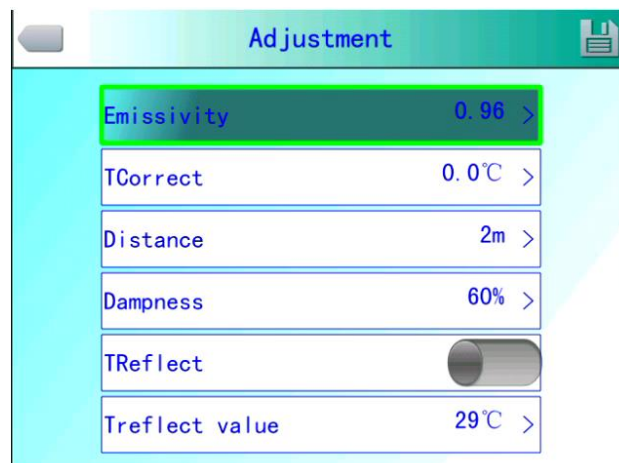

Adjustment Menu

Press OK button to call out the "Adjustment" under menu "Measuring Setting". In this menu, Emissivity, Tcorrect, Distance, Humidity, TReflect can be set. Use UP &Down button to select, use LEFT & Right to set the value. ">" means there is sub menu, press Right Button to enter the sub menu.

Emissivity: Different target has different emissivity, so the user can set different emissivity for different target. If it is not set, then will use default setting. Attached Common emissivity table for reference.

Tcorrect: Correct the target Temperature.

Distance: Setting the distance between the camera and the target to make sure exact measuring. Set the real distance if the distance is shorter than 10 meters. (Unit 0.5m)

Humidity: Set the humidity of the using environment.

TReflect: It will only functioned after it is enabled. Can use fixed temp as reference temperature.

4.6.3 Image Setting

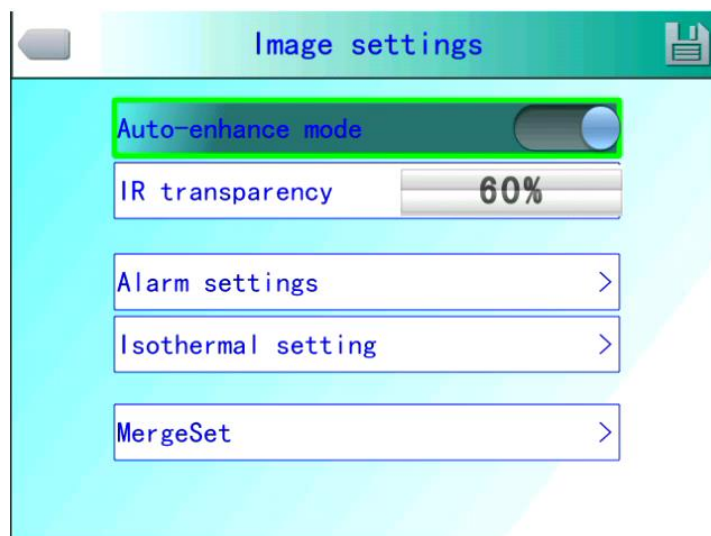

Image Setting Menu

Press OK button to call out the Image setting menu under "Setting". In this menu, **Manual/Auto-Enhance Mode, Alarm types, Alarm Tempe, IR transparency, Alarm color, Alarmlink, Tiem Interval can be set.** Use UP &Down button to select, use LEFT & Right to set the value. " > " means there is sub menu, press Right Button to enter the sub menu.

Manual/Auto/Auto-Enhance Mode: Adjust the image quality for the user to get better image for analysis purpose

When Auto-Enhance Mode is activated, can switch between manual and automatic. Press "A" button will enter manual mode, it can adjust the pallet with "UP, Down, LEFT, Right" buttons. Press "C" will return into Auto Mode.

When Auto-Enhance Mode is deactivated, can switch between manual and automatic. Press "A" button will enter manual mode, it can adjust the pallet with "UP, Down, LEFT, Right" buttons. Press "C" will return into Auto Mode.

The modes can be switched with the Auto-enhance mode Button.

If select auto mode, the camera will automatic adjust the sense of hierarchicy of the image.

If select "Auto-Enhancement ", both High temp target and low temp target can be viewed in the image.

If Select Manual mode, User can set the pallet value to adjust the image quality. Press "UP" button to increase the level range, press Down to decrease the level range. Press Left button to reduce the upper limit, increase the bottom limit; Press RIGHT button to increase the upper limit, decrease the bottom limit.

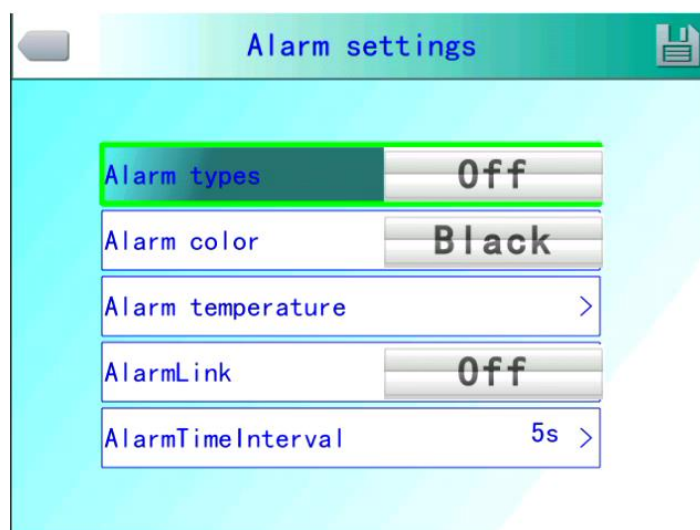

Alarm Setting

Alarm Types: It is only functioned when measuring. User can set alarm OFF, High temp alarm, Low temp alarm here. It will alarm when proper setting is selected. Alarm color can be set in "Alarm Color"

Alarm Color: The color of the target area shown on the LCD will be changed into the alarm color set when the temperature is over the alarm temp. Nine color types can be selected. If "colorless" is selected, then the color will not change when alarm.

Alarm Temperature: Setting alarm Temperature. Only functioned when it is enabled.

Alarmlink: It will automatic saved when there is alarm including snapshots and video record.

Time Interval: Set the alarmlink time interval.

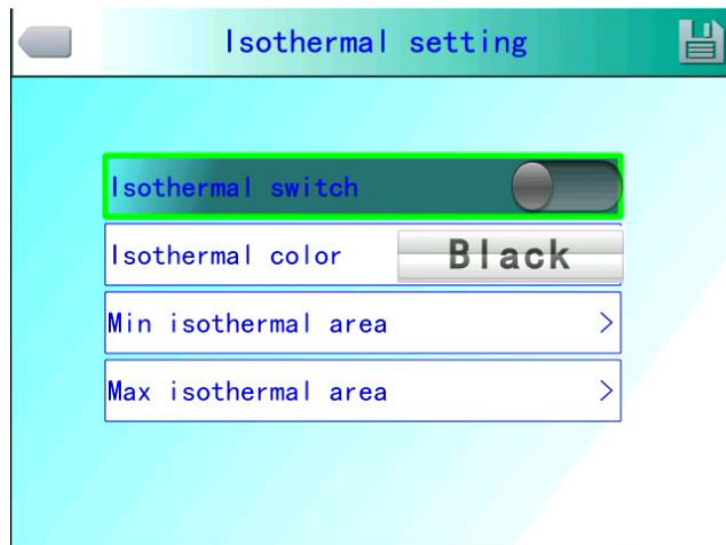

Isotherm Setup Menu

- **Isotherm:** Activates the Isotherm display by displaying the image in the set temperature range by the specified color.
- **Isotherm Color:** 9 colors available for your choice, Setting to **Off**, disables the feature.

- **Isotherm low value:** Set the Isotherm low value.
- **Isotherm upper value:** Set the Isotherm upper value.

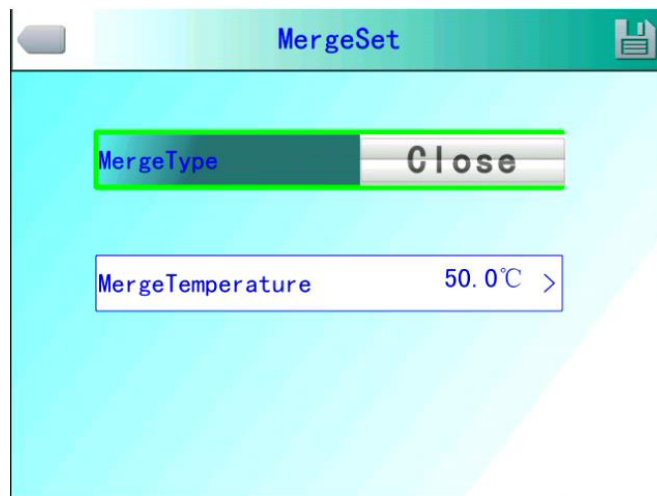

IR Fusion High & Low temperature Menu

IR Fusion High & Low temperature:

It consists of three options--IR Fusion High Temp, IR fusion Low Temp, and OFF. Set IR Fusion High Temp, when the actual temperature is higher than the temperature of IR fusion set up, CCD image will be shown. Vice versa.

4.6.4 Network setup

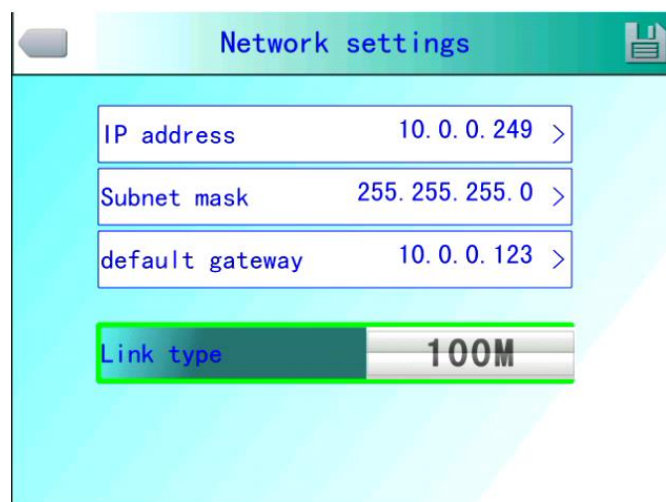

Network Setup Menu

Press the menu button to show up the floating panel and choose the

“setup” option to activate the main menu. Select “Network function.

IP Address: This IP address must be the only one, cannot be conflicted with the other IP address of the same network segment.

Sub network mask: Divide the segment of the sub network.

Default network gateway : Set the gateway address to realize the communication among different segment.

Link type: Default 10M/100M self-adapt, 10M、100M.

4.6.5 TF Card Management



TF Card Management Figure



TF Unload

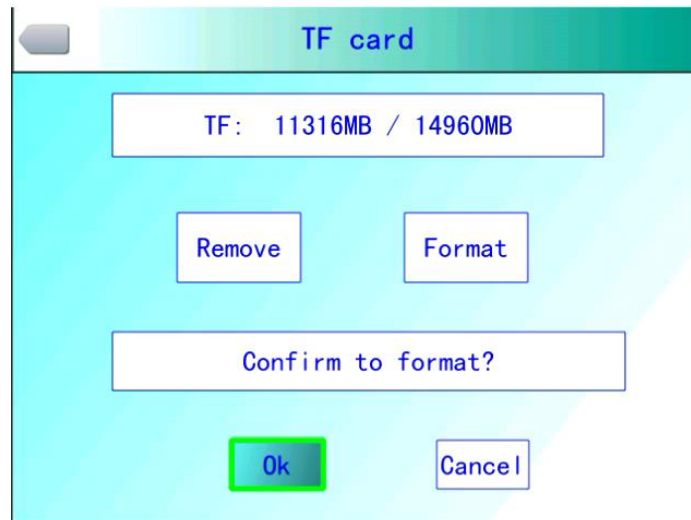

TF Card Format Figure



TF Card Format Successful

Press the Enter key to pop up floating panel, then select "Settings" option to activate the main menu, select the "TF Card Management" item in the setup menu.

Unload: Unload TF card.

Format: This function is used to format the TF card. Select the formatting options, pressing the confirm key to format, press cancel or "C" key to cancel the formatting

! Note: Verify that the file is no longer needed or have been backed up before formatting; after formation, the saved thermal imaging pictures will be lost unrecoverable. If format by PC, please select FAT16 to format the card.

4.6.6 Photo Setting



Photo Setting Menu

Pressing confirm key to pop up the floating panel, then select "Settings" option to activate the main menu, selected the camera settings option

Associated Pictures: This function is to associate the infrared images with digital image, to save the picture together.

Image annotation mode: This option has two kinds of annotations, audio annotations and text annotations. Audio annotations is to add voice when you save the picture; text annotation is to add text messages when save the image.

CS Shots: Set Continuous capture the number of sheets can be set for 1, 3, 5, 10 shot.

Continuous Capture Interval: can be 0.5s or 1s.

Record Time: can set 1、3、5、10 or 15 minutes to shut off the recording.

Manu Setting:

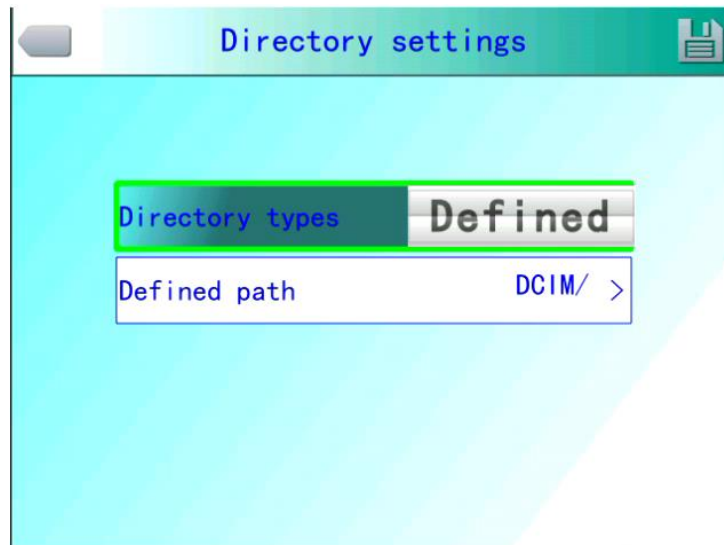

Manu Setting

Set the path to save the file, directory type can be set by custom, by month, by date. In preview mode, the playback file path set by directory type.

4.6.7 System Setting



System Setting Manu

Press the Enter key to pop up "Settings" option to activate the main menu, select "System Settings" item in the setup menu. Users can customize the set system language, time / date formats, time / date, restore the factory value items. Pressing the up/down key to switch the setting, use left and right arrow

keys to set the contents of the setting. The ">" indicates that there's a lower-level menu, use right-click to enter.

Language: Set the languages

Time / Date Format:

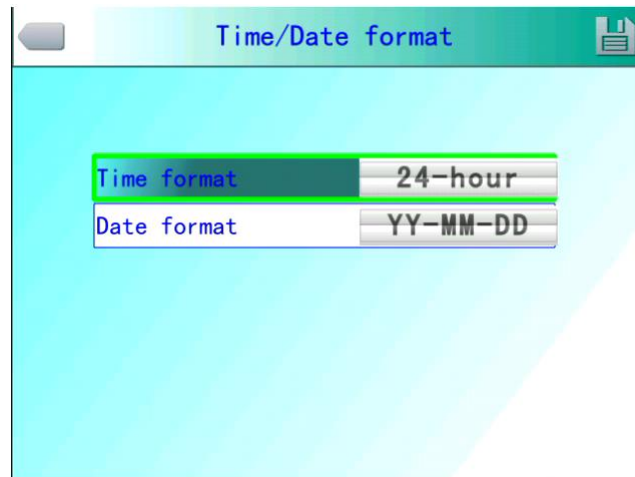

Time/Date Setting Menu

Change the format of the time/date

Time Setting:



Time Setting Menu

Customer can via the Time Setting menu to set the thermal imaging camera's time. After the setting, the data the time will be saved.

Users can customize to set the year, month, day, hour, minute entries. Press the left and right key to do the settings.

! Note: When left unused for a long time, due to the limited internal battery power, the thermal imaging camera need to re-adjust the system time.

Restore the factory settings: this function is used to restore the factory settings. Pressing the confirmation button, the setting menu will come up, continue to press the confirm key system to restore the factory settings. When pressing the cancel button to exit, the restore the factory settings will be cancelled. The details of the thermal imaging camera' factory parameters listed please see the Annex parameter table.



Recover Factory Setting

! Note: Recover factory setting will cancel all user-defined parameters.

System Version Info:

Model: TT-ET2W-HTI
 Device No:23ET2WA13001
 Version:V0.1.28 20130131

System Version Figure

Display thermal imaging device model, device number, software version number and MAC address

Import: New TF card the Create DCIM / Import directory on the TF card;
import the fixed file name as PicNote.cfg

File Name Form:

[Note]

Note1 =

Note2 =

Note3 =

Each line is not more than 20 words. After the import is complete, restart the instrument to take effect.

Export: TF card, make sure the TF card is in the machine, then select the menu and then click the Export button to export the contents stored in the TF card the DCIM / Export directory.

4.7 File Management

4.7.1 Playback

Two modes of playback:



File Management Figure

- 1、 File management mode: press the Enter key to pop up floating panel select "Settings" option to activate the main menu, select the file management menu in the setup menu, press the confirm button to open the infrared image in the storage. The image arrangement format has abalone grid, press the upper, lower, left, and right arrow keys can switched the stored image. Pressing the "C" key to exit open image and return to the measurement state.

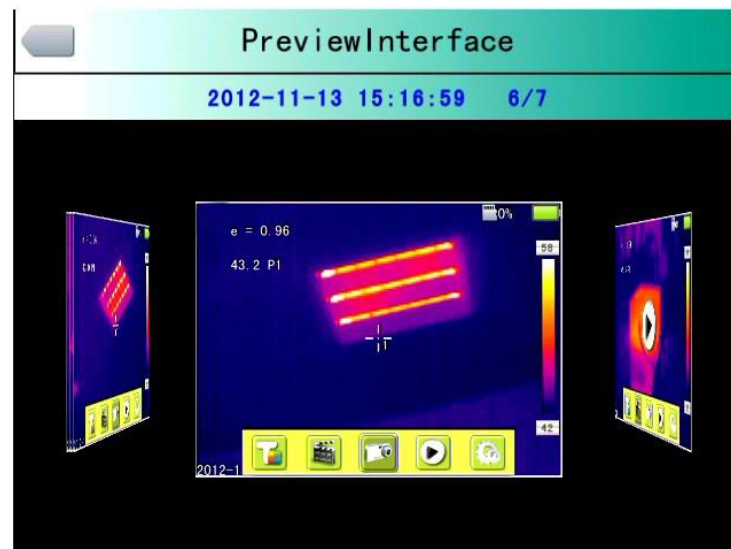

Preview Mode Figure

- 2、 Preview mode: press the OK button to pop-up floating panel to select "Preview" option, enter the preview mode. Through the left and right keys to switch selection, selected press the OK button to enter the playback. Pressing the "C" key to exit open image and return to the measurement state.

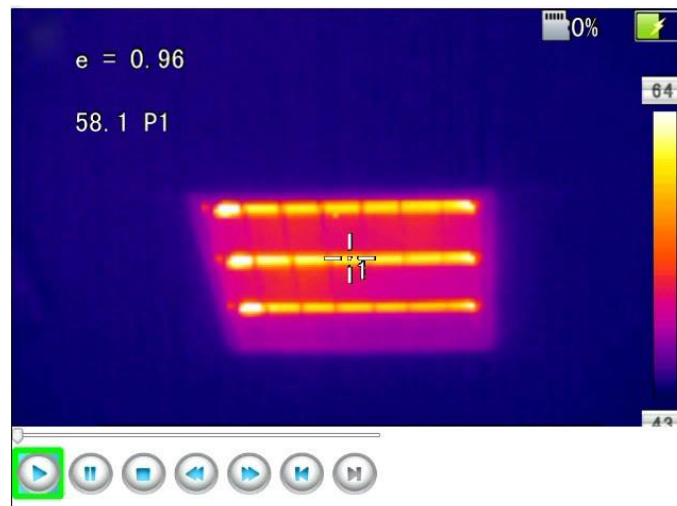

Video Playback Interface

Video playback interface: Via the left and right key to select the play button on the status bar, press the "confirm" key to take effect on the next key to show and hide the playback status bar (press the "on" button is displayed, press the "next" button is hidden)

The icon buttons from left to right is as follow: play / pause, stop, rewind, fast-forward, the former one, the next.

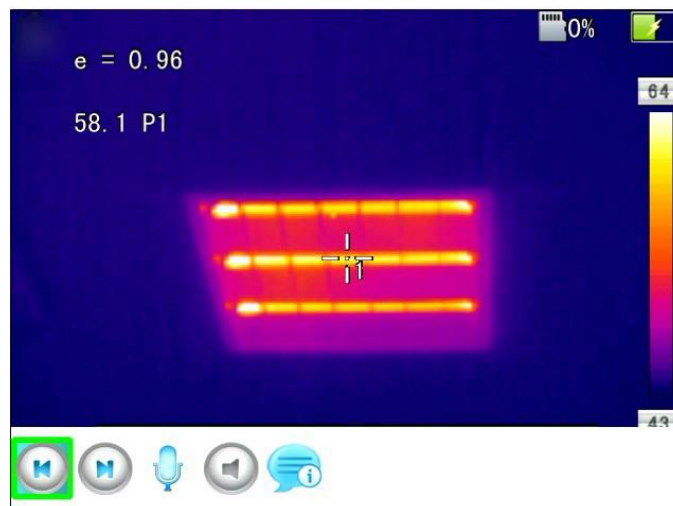

Image Playback Interface

The image playback interface: Via the left, right key to select the play button on the status bar, press the "confirm" key to take effect on the next key to show and hide the playback status bar (press the "on" button is displayed, press the "next" button is hidden)

The icon buttons from left to right is as follows: the former one (above), the next (paragraph), sound recording, voice playback, text playback.

4.7.2 Bluetooth Transmission

This function is used to transfer the stored images on TF card. First, turn on Bluetooth, then open the file manager, and the arrow keys to select the files you want to transfer and Bluetooth transmission prompt box pops up, press the "A" key, as shown below:

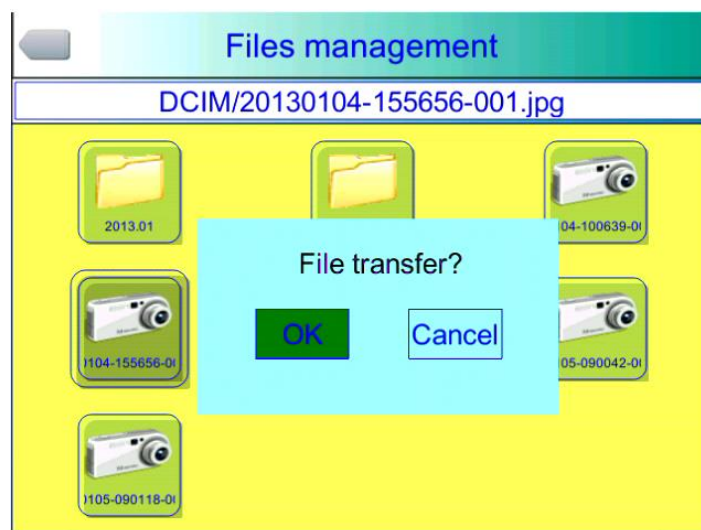

Bluetooth Transmission Figure

Press confirm key, will show the progress bar, as shown below:

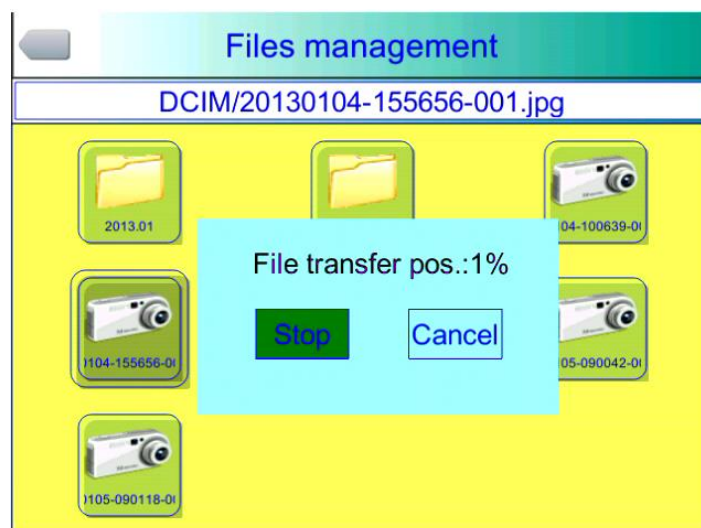

Transmission Progress Bar

4.7.3 Delete

This function is used to delete data stored in files on the TF card. Open File Manager by the up and down keys to select the file you want to delete, press the "S" key to bring up the prompt box, delete the currently selected image files when the Enter key is pressed, the image voice or text comments will also be deleted, then press the "C" key to undelete

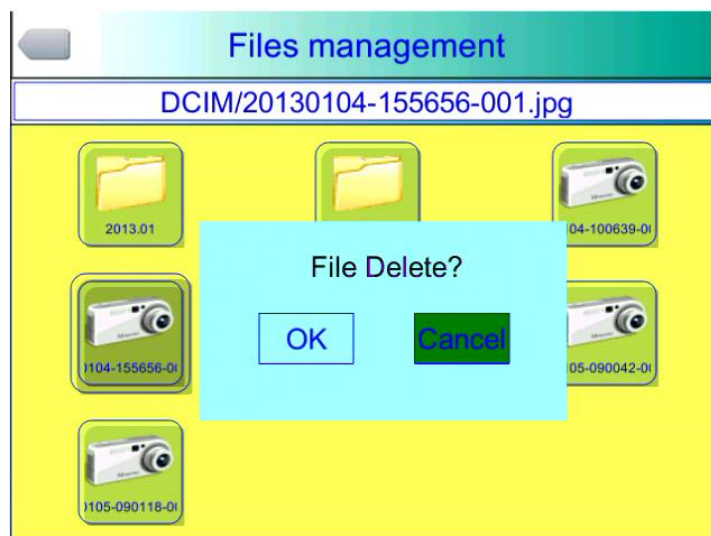

File Delete Figure

! Note : Before deletion, make sure that the file is no longer needed or have backup, the deleted image cannot be recovered

5 Webpage operate

5.1 Webpage login

Will pop up a menu after inputting the IP of camera, as bellow:



Login user

Password

Please download OCX control if it is your first time to contact the machine.

[Click here](#)

Login interface

User ID and code both is admin .Enter the operate menu after press the login. If ActiveX cannot download automatically. Please, download manually.

5.2 Surveillance image

Surveillance image will be shown as follow :

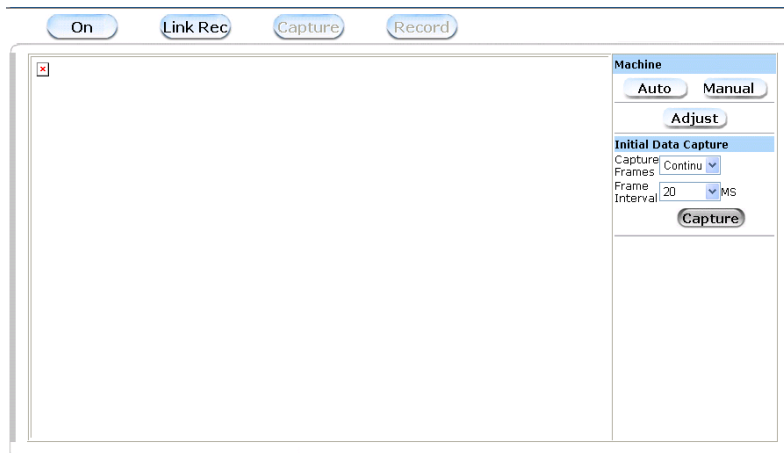

Monitoring Figure

Switch : Switch on /off to open and close the image

Link save : save the thermal image and visual image both

Local capture: Save image in BMP format

Local record : Save the video in AVI format

Automatic /manually: refer to manual.

Calibration : refer to manual .

Original data save: There are two types. One is frame rate

Another is interval time between two frames. Frames rate means frames per seconds. Could set as different modes like continuous /5/20/50/100/random. Interval time means time between two-frame .it could also set different modes .like 20/40/100/200/1000/random.

5.3 Function operate

Press buttons are shown in the left in the screen:



Buttons

5.3.1 System parameter set

System parameter menu will pop up after login:

Sys. Config

Time Configuration

System Time

Time Adjust Keep current time
 Synchro with PC time
 Manual setting
 Synchro with NTP time

- - : :

NTP server

Update interval Minute

Time Zone

System Parameter

Auto Calibration Time Second

Unit Distance

LCD Bright

Time of close led Minute

Time of close power Minute

Time Format

Data Format

Shortcut Settings

Up Key

Down Key

Left Key

Right Key

Function Key

System Configuration Menu

The menu include the setting for time, for system setting and for the short key, see as the operation guide.

5.3.2 Photo Setting

Click photo setting, and come to the setting menu, see as the follow:

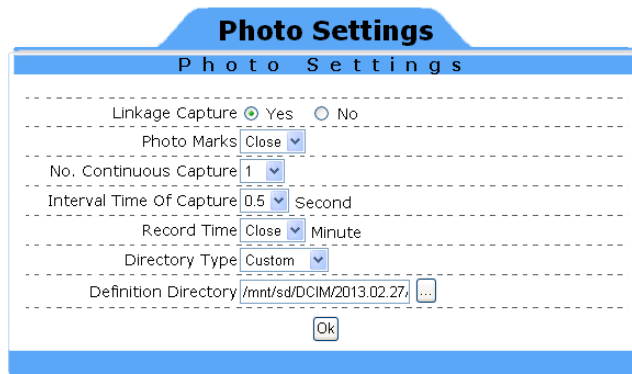
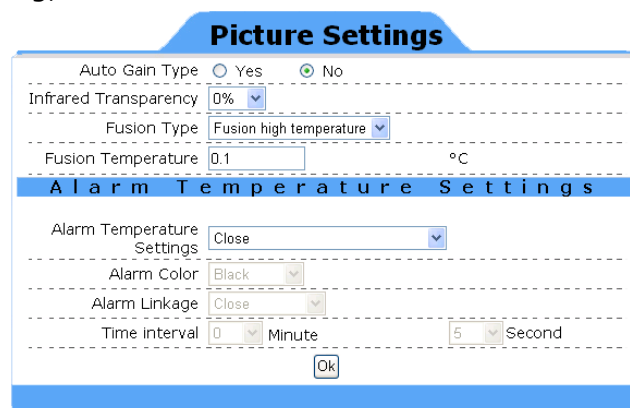

Photo Setting

The details please see as the operation guide

5.3.3 Graphic setting

Click the setting, and see as the follow:



Graphic Setting

It include tow sub-menu, one is graphic setting, and another is the alarm setting.

5.3.4 Measurement Setting

Click the measurement setting, and see as follow:

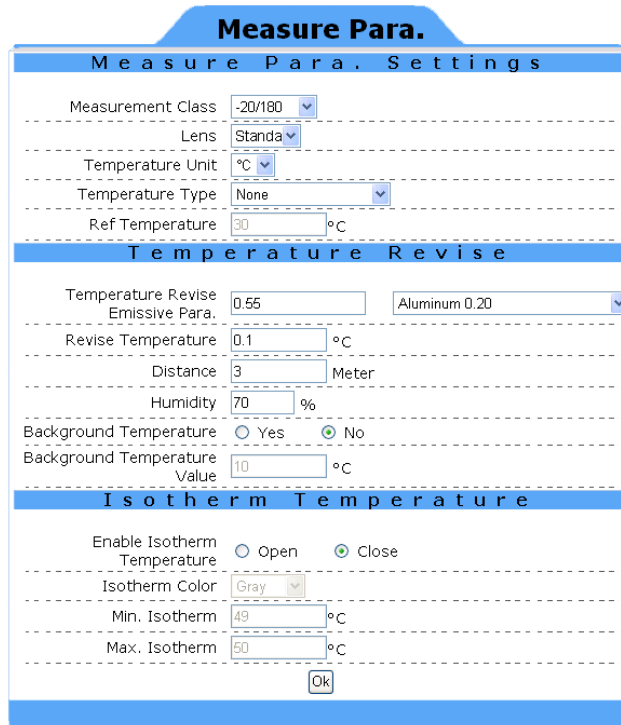

Measure Para.

Measure Para. Settings

Measurement Class: -20/180
 Lens: Standa
 Temperature Unit: °C
 Temperature Type: None
 Ref Temperature: 30 °C

Temperature Revise

Temperature Revise Emissive Para.: 0.55 Aluminum 0.20
 Revise Temperature: 0.1 °C
 Distance: 3 Meter
 Humidity: 70 %
 Background Temperature: Yes No
 Background Temperature Value: 10 °C

Isotherm Temperature

Enable Isotherm Temperature: Open Close
 Isotherm Color: Gray
 Min. Isotherm: 49 °C
 Max. Isotherm: 50 °C

Ok

Measuring Parameters Menu

Under Measuring Parameters Menu, there are sub-menu of Measuring Settings, measuring correction and isothermal. For the detailed function operation, please refer the operation manual.

5.3.5 Network

User can enter network setting with pressing network button, refer below picture

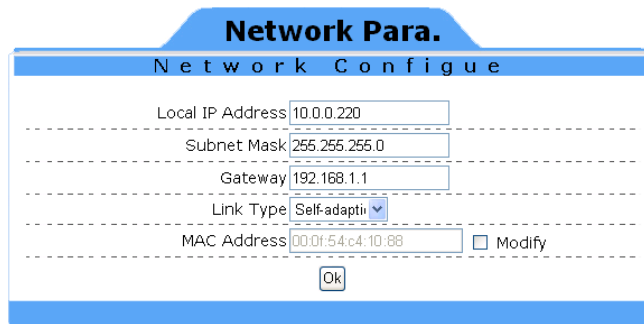

Network Para.

Network Configure

Local IP Address: 10.0.0.220
 Subnet Mask: 255.255.255.0
 Gateway: 192.168.1.1
 Link Type: Self-Adaptiv
 MAC Address: 00:0f:54:c4:10:88 Modify

Ok

Network setting Menu

Refer the operation manual for the detailed functional descriptions.

5.3.6 Local Settings

Press Local settings can enter into local settings menu. Refer below picture:

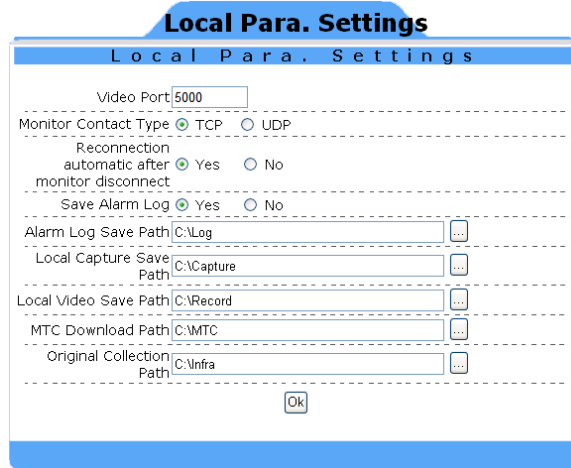

Menu of local settings

Default Video port number is 5000. User can define the file saving path.

5.3.7 System Maintenance

Press System Maintenance will show menu as below picture:



Sub-menu

Restore factory Setting: Refer operation Manual for detailed function description.

Press Firmware update, it will switch into upgrade interface as below:

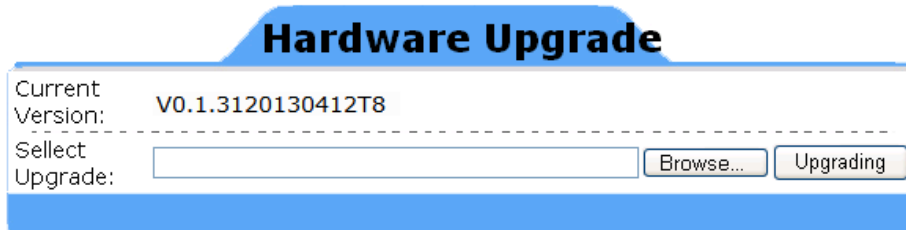

Hardware Upgrade Figure

Upload/download configuration: click this function, and will see as follow:

Up/Download Config Files

Save Current

Settings

Please Choose Configure

Files

Upload/download configuration figure

System State: Click system situation, then will see :

System Status

Network Parameter

DHCP	<input type="text" value="OFF"/>
IP	<input type="text" value="10.0.0.220"/>
Subnet Mask	<input type="text" value="255.255.255.0"/>
Gateway	<input type="text" value="192.168.1.1"/>
MAC Address	<input type="text" value="00:0f:54:c4:10:88"/>
PPPoE	<input type="text" value="OFF"/>

System Info

Type	<input type="text" value="TT-ET2W-HTI"/>
Device Serial Number	<input type="text" value="22ET2WA0224"/>
Version Number	<input type="text" value="V0.1.3120130412T8"/>

System State Figure

6 Configuration

Item		<i>ThermalTronix TT-ET2W-HTI</i>
Detector	Type	Un-cooled FPA micro-bolometer
	Array size	384*288
	Pixel Pitch	25µm
	Spectral range	8-14µm
	Frame rate	50Hz
	Thermal sensitivity	0.06°C@30°C
Lens	FOV	25°×19°
	Min Focus Distance	10cm
	Focus	Manual
	Interface Type	Screw Type
Image	IFOV	1.36mrad
	Zoom	2×、4X
	CCD	3 million pixel, CMOS module
	Frame Rare	50HZ/60HZ,
	Video Output	PAL / NTSC
Image Display	LCD display	3.6" TFT LCD, 640*480, touch screen
	Color Palette	11 color palette for option
	Image adjustment	Auto/manual to adjust brightness, contrast
	Image	Fast switch between infrared image and ccd image, with fusion function.
	Image Enhance	Auto/manual enhance mode
Measurements	Range	+30°C~+42°C
	Accuracy	± 1 °C
	Measurement Correction	Auto / Manual
	Mode	Up to 5 movable spots. Up to 5 movable areas (maximum, minimum and average temperatures). Up to 2 movable lines. Line profile. Isotherms. Temperature difference. Alarm(voice, color)
	Emissivity correction	Variable from 0.01 to 1.0
	Background Tem correction	Auto
	Atmospheric transmission correction	Automatic correction according to user input object distance, humidity and temperature

	Setting Option	Time/Date, °C/°F/K, language, brightness/contrast, LCD brightness, IP address
Image Storage	Card	8GB Micro TF card, max 32GB
	Mode	Auto/manual saving, single thermal images and CCD image association, thermal video and CCD association, thermal and CCD fusion function.
	Format	JPEG format H.264 format
	CCD image format	JPEG、H.264, include fusion
	Voice annotation	60s, saved together with the image
	Text annotation	can upload
	File Manu	can upload
Power source	Battery type	Li-Ion, rechargeable
	Battery operating time	3 hours continuous operation
	charging	Intelligent charge or power adaptor or 12v car power charge
	Charging time	1.5 hour to 50% full
	Power saving	auto sleep, auto shut down
Interface	SD card slot	Micro SD (TF) slot
	Net power	Mini-USB (DC12V)
	video	yes
	Auto/data	Bluetooth(earphone/RS232)
Other	Mic	yes
	buzzer	yes
	Flash light	2 LED
	Laser point	red, 1mw/635nm, two level, IEC60285
	Triple	1/4"-20-UNC
	Hand strap	Can install on two side
	Lens cover	yes
Sky shade	yes	
Environment	Operation temperature	-15°C~+50°C
	Save temperature	-40°C~+70°C
	Humidity	≤90%
	Encapsulation	IP54
	Shock resistance	25G, IEC68-2-29
	Vibration resistance	2G, IEC68-2-6
	Drop resistance	2 meters
Dimensions	Dimension	105x230x245mm
	weight	980g

7 Troubleshooting

Please follow the table below to diagnose and correct the problem. If problem still exists, please contact our service department.

Problem	Cause & Solution
The camera does not power on.	<ul style="list-style-type: none"> ● Battery not installed or installed incorrectly →Install battery or re-install battery ● Battery is out of power. →Change battery. ● "Power off" protection is enabled →Wait for 5 seconds and reboot.
The camera powers off automatically.	<ul style="list-style-type: none"> ● Battery is out of power. →Change battery ● Auto-Off Time option is enabled →Set as None.
Battery depletion is too fast	<ul style="list-style-type: none"> ● Environmental temperature is too low ● Rechargeable battery is not charged completely. →Recharge the battery. ● Rechargeable battery is out of power completely and cannot be recharged. →Change to new battery.
No thermal image	<ul style="list-style-type: none"> ● Lens cover is not removed. →Remove lens cover. ● In image freeze status →Press C key to exit.
Thermal image is white-black.	<ul style="list-style-type: none"> ● White-black palette is selected →Select normal palette.