

ThermalTronix
TT-L-BFTC Series
Thermal Imaging Camera

User Manual





Warnings

- Please avoid aiming the lens at extreme high temperature radiation source, such as the sun, molten steel or laser in any situation; otherwise the detector may be damaged.
- Please do not touch the lens to avoid contaminating and damaging. Please pay attention to protect the lens to avoid causing abrasion, scratches even breaches, otherwise, it will affect the device performance badly, even damage the device.
- This device is a precise optoelectronic product. Please protect it properly during usage, storage and transportation, where improper use (such as drop and collision) will cause damage to the device. If the internal connection is broken during the assembly process or the apparatus is damped (rain wet), the performance will be reduced and even the device will be damaged.
- Make sure that the power control connection is reliable. If the power control wire is in bad connection, it will damage the device.
- Ensure the proper connection of power control cable and data cable. Wrong connection may cause damage to the device.
- Do not swag fiercely or collide the device during transportation, otherwise it will cause performance-reduction and even damage to it.
- Please use the specified power supply; otherwise it will cause improper working, even damaging the apparatus.

If the product works abnormally, please contact the dealer or the nearest after-sale service center. Please do not dismantle or replace it in any manners.

Contents

1. Overview.....	3
1.1 Features:.....	3
1.2 Applications:.....	3
1.3 Interface definition.....	3
1.4 Protocol setup	4
1.5 Function key chart.....	4
1.6 Guide for call the Preset.....	4
2. Operations.....	6
2.1 Main menu	6
2.2 Sub-menu operations.....	7
2.3 COM sub-menu	9
2.4 Configuration sub menu.....	10
2.5 Alarm Valve sub-menu	11
3. Specifications.....	13

1. Overview

1.1 Features:

384*288 uncooled detector

2X Digital zoom

Black hot/White hot switch

Automatic/Manual calibration

PAL/NTSC mode video output

RS485 interface, support PELCO-D/PELCO-P protocol

Athermalized, focus free lens

Weatherproof, IP66

1.2 Applications:

Road monitoring, perimeter guard, channel management, marine reconnaissance patrol, etc.

1.3 Interface definition

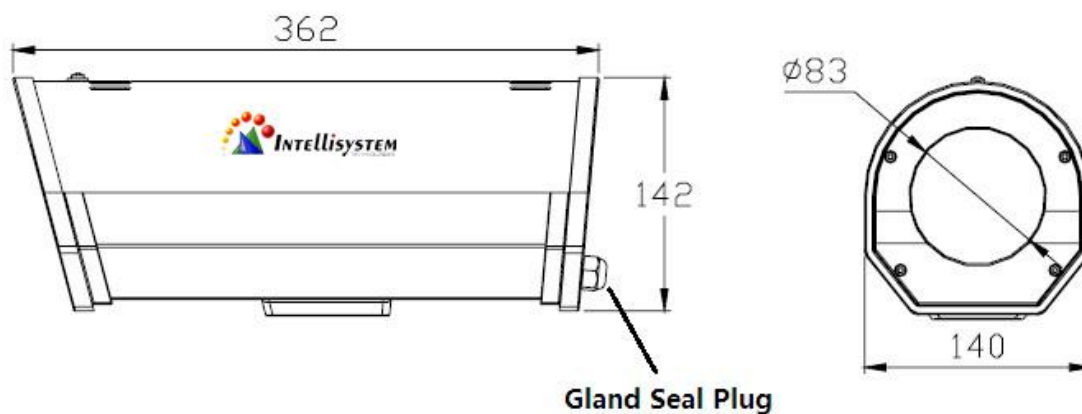

The control wire is from gland seal plug of housing.

Definition as follows:

No.	Description	Remark
1	RS485	RS485+
2		RS485-
5	IR Video	Analog video output of thermal imaging camera
6	DC12V	Power supply
7		

1.4 Protocol setup

Factory default : RS485、 PELCO-D、 baud 2400、 add 1。

Protocol : PELCO-D/P

Baud : 2400、 4800、 9600、 19200

ADD : 0~254

1.5 Function key chart

Camera Communication Default settings (RS485)-> Address:1 Baud:2400 Protocol: PELCO-D

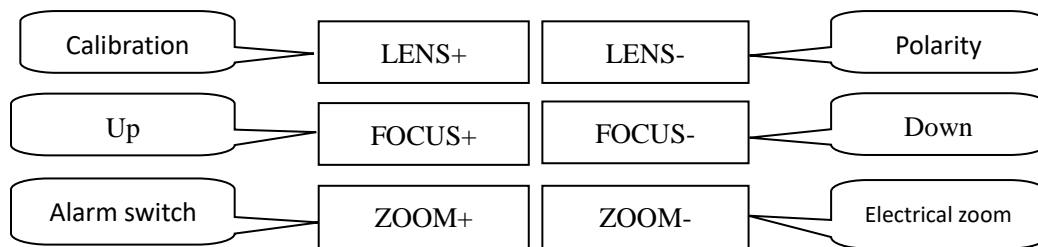

1.6 Guide for call the Preset

A、 call preset to popup the menu

Call preset 100 popup menus and press key “LENS-” to change the items

B、 call preset to setup the alarm range

Call preset 101 to switch the alarm range

C、 call preset to change the Protocol

Call preset 106 changes to PELCO-D

Call preset 107 changes to PELCO-P

D、 call preset to change the Baud rate

Call preset 108 changes to baud 2400

Call preset 109 changes to baud 4800

Call preset 110 changes to baud 9600

E、 call preset to change the address of thermal camera

Call preset 111 to changes to address 1

Call preset 112 to changes to address 2

Call preset 113 to changes to address 13

.....

Call preset 127 to changes to address 17

2. Operations

2.1 Main menu

Without the menu call preset **100**. enter the main menu , pic 1 :

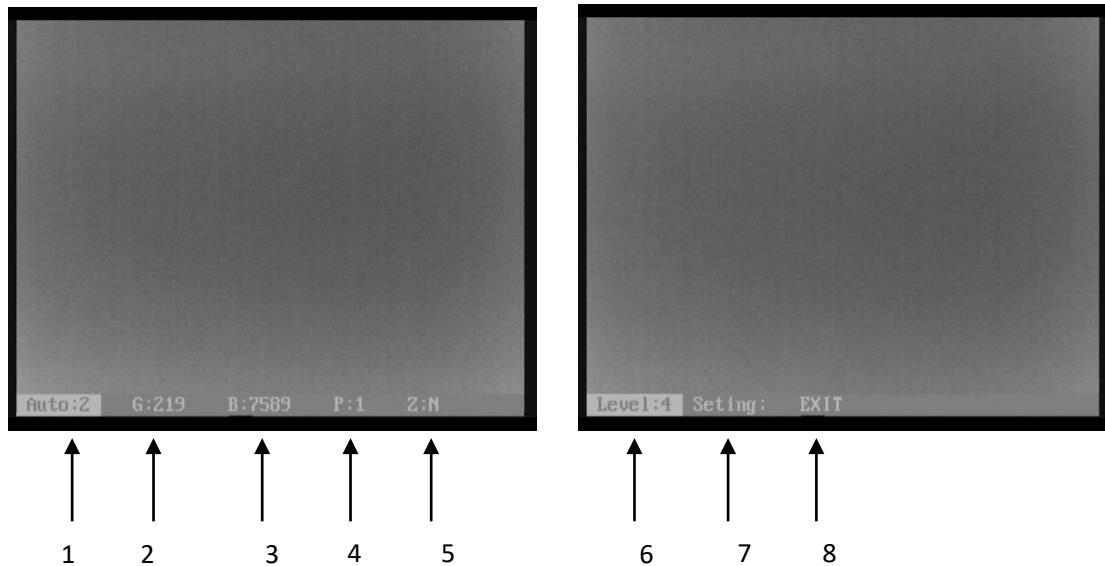

Pic 1

Press key “LENS-” move the cursor , Press key “FOCUS+” or “FOCUS-” to change the value where the cursor is . Auto save when exit

1、 **Auto: XXX** Display the current image auto mode. Three options:

0: manual gain, manual brightness;

1: manual gain, auto brightness;

2: auto gain, auto brightness; (Factory default)

2、 **G: XXX** Gain value, range: 1 ~ 1023 ;

3、 **B: XXX** Brightness value, range

4、 **P: XXX** White/black hot display mode

0: black hot 1: white hot

5、 **ZOOM : Y/N** Zoom status

N : no zoom (default) Y : Zoom 2 times

6、 **Alarm range : X** show the range of alarm : From 1 to 6, default is 4

7、 **Setup :** Press key “FOCUS+” or “FOCUS-” , show the password dialogue

Press “FOCUS+、 FOCUS-、 FOCUS+、 FOCUS-、 FOCUS+、 FOCUS-” to enter sub menu dialogue

Note :

- All parameters are save automatically after exit
- The camera will run the last setup after reboot

2.2 Sub-menu operations

In the main menu, move the cursor to “setup” ,press key “FOCUS+” or “FOCUS-” show the password dialogue , Input the password , refer to Pic 2



Pic 2

Press key : “FOCUS+、 FOCUS-、 FOCUS+、 FOCUS-、 FOCUS+、 FOCUS-” , to enter , refer to Pic 3 :

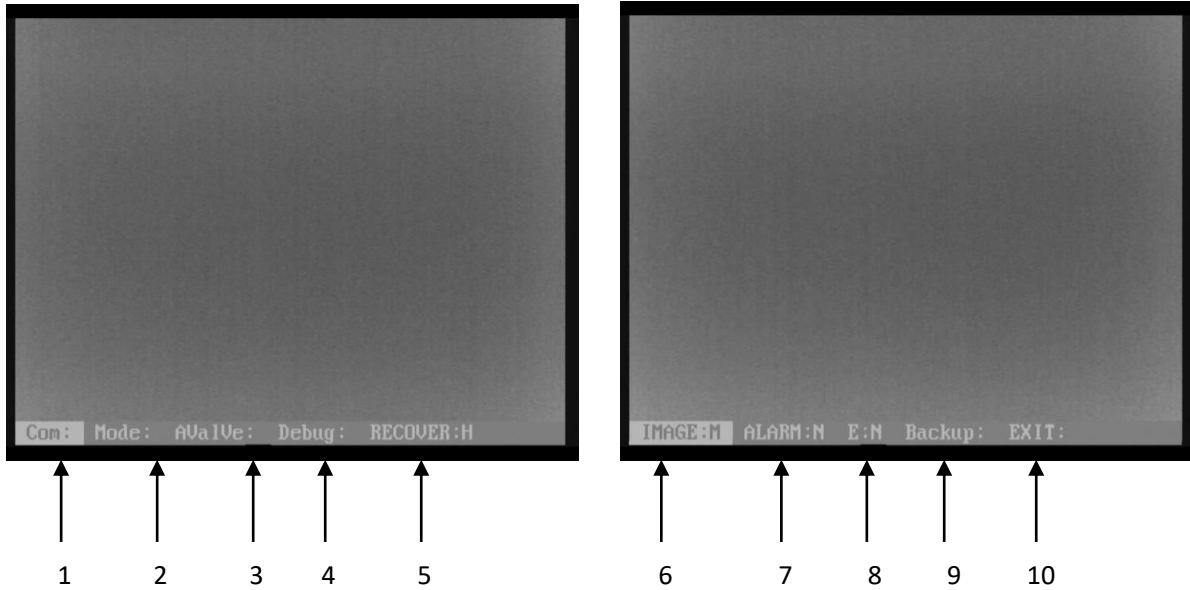

Pic 3

Press key “LENS-” move the cursor , Press key “FOCUS+” or “FOCUS-” to change the value where the cursor is . Auto save when exit

- 1、 **COM:** press key “FOCUS+” or “FOCUS-” show the password dialogue ,Input the password “FOCUS+、 FOCUS-、 FOCUS+、 FOCUS-、 FOCUS+、 FOCUS-” enter the level 3 sub menu
- 2、 **Configuration :** press key “FOCUS+” or “FOCUS-” show the password dialogue , Input the password “FOCUS+、 FOCUS-、 FOCUS+、 FOCUS-、 FOCUS+、 FOCUS-” enter the level 3 sub menu
- 3、 **Alarm Valve:** press key “FOCUS+” or “FOCUS-” show the password dialogue , Input the password “FOCUS+、 FOCUS-、 FOCUS+、 FOCUS-、 FOCUS+、 FOCUS-” enter the level 3 sub menu
- 4、 **Test:** press key “FOCUS+” or “FOCUS-” show the password dialogue , Input the password “FOCUS+、 FOCUS-、 FOCUS+、 FOCUS-、 FOCUS+、 FOCUS-” enter the level 3 sub menu
- 5、 **Calibration : long/short/close** Setup as long /short/close ;

Setup as long : Calibrate 1 time during the 1 minute if working time less than 10 minutes. Calibrate 1 time during 2 minutes if working time between 10 and 30 minutes .calibrate 1 time during 5 minutes if working time between 30 minutes and 1 hour. Calibrate 1 time during 10 minutes if working time more than 1 hour. Calibrate 1 time during 20 minutes if working time more than 2 hours.

Setup as short : Calibrate 1 time during the 1 minute if working time less than 0 minute. Calibrate 1 time during 2 minutes if working time between 10 and 30 minutes .calibrate 1 time during 5 minutes if working time more than 30 minutes

Setup as /close : calibrate manually ;

6、 **Image: high/middle/low** setup as high/middle/low ;

Each grade relatively corresponds to a value. It could be setup in the TEST menu .default is middle

7、 **Alarm : X** show the status of gray alarm : N/Y

N: off ; (Default) Y: On

8、 **Gain : X** Show the status of Gain , setup as C/1/2 ;

C: Close ; (default) 1/2 : Open relatively Gain grade

9、 **Default :** factory default , including auto , polarity , alarm range , calibration , image ,

alarm , alarm pixel Number。

10、 **Exit : XXX** press key “FOCUS+” or “FOCUS-” to exit

2.3 COM sub-menu

First : ; Without the menu call preset 100. Enter the main menu. In the main menu, press the key

“LENS-“ move the cursor to “setup” ,press key “FOCUS+” or “FOCUS-” show the password dialogue ,Input

the password. “FOCUS+、 FOCUS-、 FOCUS+、 FOCUS-、 FOCUS+、 FOCUS-” enter the sub menu

Second : After login Sub-menu. press the key “LENS-“ move the cursor to “COM” key .press key “FOCUS+”

or “FOCUS-” show the password dialogue , Input the password. “FOCUS+、 FOCUS-、 FOCUS+、 FOCUS-、

FOCUS+、 FOCUS-” enter the level 3 sub menu .Refer to Pic 4

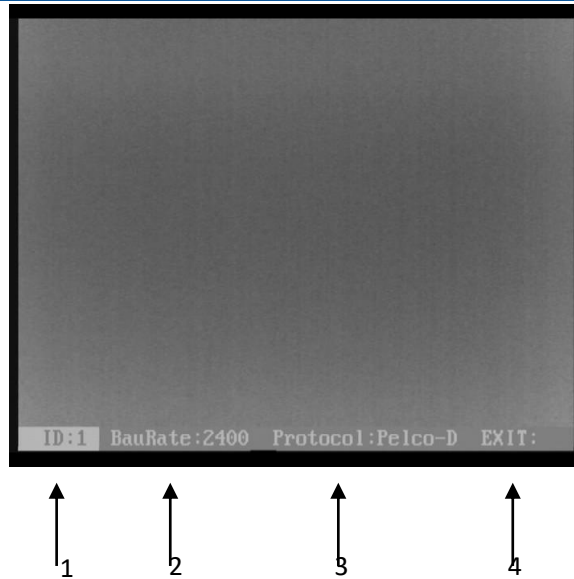

Pic 4

In the menu “COM”, ,Press key “LENS-” move the cursor ,Press key “FOCUS+” or “FOCUS-” to change the value where the cursor is 。 Auto save when exit

- 1、 **Add : XXX** ADD : 0~254。
- 2、 **Baud : XXX** Baud :1200,2400,4800,9600,14400,19200,38400。
- 3、 **Protocol :** PELCO-D/P。
- 4、 **Exit :** Press key LENS+ to exit

Default : Add:1 Baud:2400 Protocol: PELCO-D

2.4 Configuration sub menu

First : Without the menu call preset 100. Enter the main menu. In the main menu, press the key “LENS-” move the cursor to “setup” ,press key “FOCUS+” or “FOCUS-” show the password dialogue ,Input the password. “FOCUS+, FOCUS-, FOCUS+, FOCUS-, FOCUS+, FOCUS-” enter the sub menu

Second : : After login Sub-menu. press the key “LENS-” move the cursor to “Configuration” key .press key

“FOCUS+” or “FOCUS-” show the password dialogue , Input the password. “FOCUS+、 FOCUS-、 FOCUS+、 FOCUS-、 FOCUS+、 FOCUS-” enter the level 3 sub menu. Refer to Pic 5

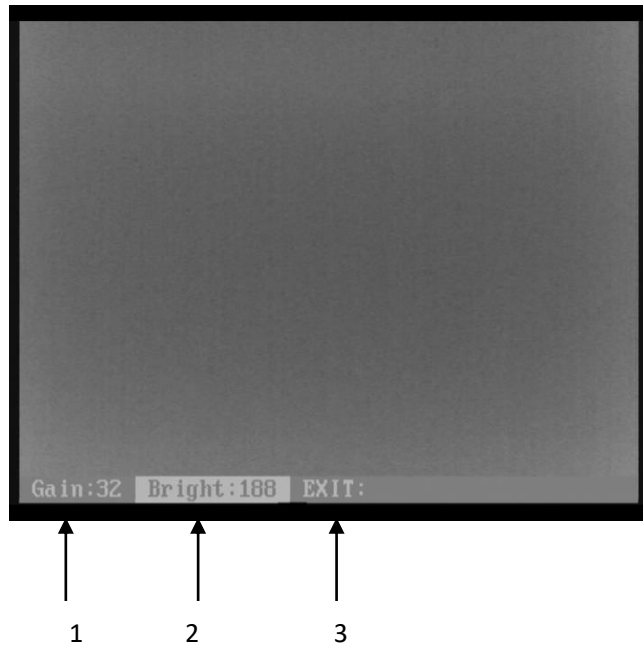

Pic5

In the menu “Configuration” , Press key “LENS-” move the cursor , Press key “FOCUS+” or “FOCUS-” to change the value where the cursor is . Auto save when exit

- 1、 **G : XXX** Range: 0~255。
- 2、 **B : XXX** Range: 0~255。
- 3、 **Exit :** Press key LENS+ to exit

Default : G:32 B: 188

2.5 Alarm Valve sub-menu

First : Without the menu call preset 100. Enter the main menu. In the main menu, press the key “LENS-” move the cursor to “setup” ,press key “FOCUS+” or “FOCUS-” show the password dialogue ,Input the password. “FOCUS+、 FOCUS-、 FOCUS+、 FOCUS-、 FOCUS+、 FOCUS-” enter the sub menu

Second : After login Sub-menu. press the key “LENS-” move the cursor to “Alarm Valve” key .press key “FOCUS+” or “FOCUS-” show the password dialogue , Input the password. “FOCUS+、 FOCUS-、 FOCUS+、 FOCUS-、 FOCUS+、 FOCUS-” enter the level 3 sub menu. ; Refer to pic 6 :

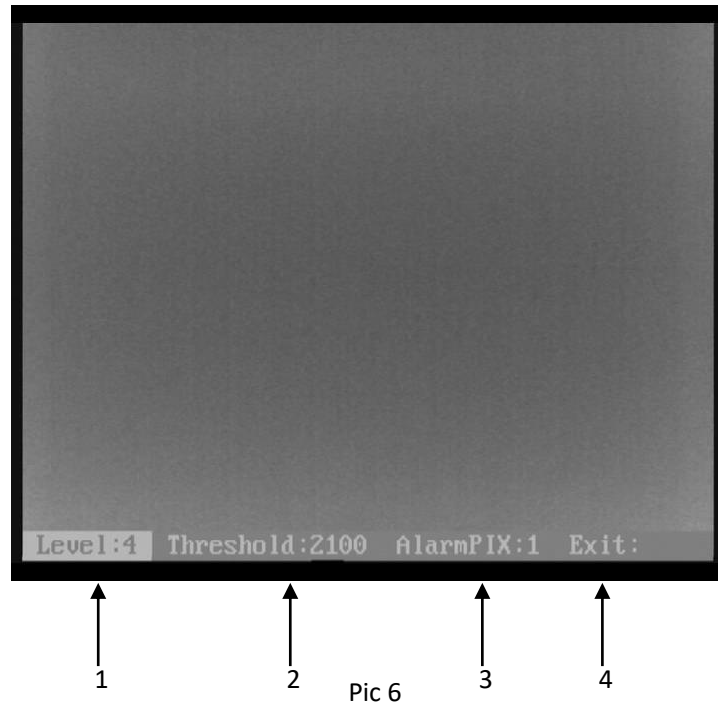

In the menu “Alarm Valve”, ,Press key “LENS-” move the cursor ,Press key “FOCUS+” or “FOCUS-” to change the value where the cursor is 。 Auto save when exit

- 1、 **Alarm range : X** Range: 1~6。
- 2、 **Alarm Valve : XXX** Show the status of Alarm Valve 。
- 3、 **Alarm pixel Number : XXX** 。 Show and setup for minimum I number of alarm.
Such as alarm Number 2 .so the alarm pixel is 2* 2 .totally 4 pixels
- 4、 **Exit :** Press key LENS+ to exit。

Default: Alarm range and alarm valve :(grade 1: 650, relatively temperature difference is 30 °C;Grade 2:1050, relatively temperature difference is 45 °C;Grade 3:1450, relatively temperature difference is 60 °C;Grade 4:2100, relatively temperature difference is 80 °C;Grade 5:2800, relatively temperature

difference is 100 °C; Grade 6:3600, relatively temperature difference is 120 °C) alarm pixel number :1.

3. Specifications

Items		ThermalTronix			
		TT-1009L-BFTC	TT-1018L-BFTC	TT-1037L-BFTC	TT-1050L-BFTC
Detector characteristics	Detector type	Uncooled FPA microbolometer			
	Array size	384x288			
	Pixel	25um			
	Spectral range	8 ~ 14um			
	Frame rate	50HZ			
Lens	Focal length	9mm	18mm	37mm	50mm
	F number	F1.1			
	Focus	Athermalized, focus-free			
	Free focus range	0.8m~∞	3m~∞	12m~∞	23m~∞
Functions	NETD	≤100mK			
	Gain/Brightness adjustment	Manual brightness/gain; auto brightness/manual gain; auto brightness/gain			
	Polarity inversion	White/black hot mode			
	Digital zoom	2X			
	Calibration	Automatic/manual			
	Grayscale alarm	Yes			
Interface	External power	DC10V-15V			
	Power consumption	≤2.2W			
	Video output	PAL			
	Remote control interface	RS485 , PELCO-D/P Protocol			
Environment	Operation temperature	-20°C~ +50°C			
	Storage temperature	-40°C~ +70°C			
	Weight	≤3KG			
	Size (mm)	362*140*145			

Note: Specifications are subject to change without notice