ThermalTronix
TT-1730S-NVBM
Thermal Image Camera

Operator's Manual



Warning and Attention



Warnings

- Never put the lens directly towards the strong radiation source (the Sun, direct or reflection laser beam, etc) in any situation (power on or power off) since thermal inductor used in infrared camera is very sensitive. Otherwise, infrared camera will be damaged permanently.
- The original package box must be used in the transportation. Do not shake or hit the apparatus strongly in use and transportation.
- Please use the original package box to store the apparatus. The environment should be cool, dry, ventilated and no strong electromagnetic field.
- Protect the surface of the lens from being stained or damaged by oil sludge and any chemical matters. Please put on the lens cap after using.
- Please remember to backup the data into PC instantly in order to avoid losing the important data.
- Never open the case or refit the apparatus. Only authorized people from our company are allowed to do maintenance.

If the product works abnormally, please contact the dealer or the nearest after-sale service center. Please do not dismantle or replace it in any manners.

Content

Warning and Attention	1
1. Accessories	3
2. Camera Overview.....	4
2.1 Function Button.....	5
2.2 Input & output connectors.....	7
3. Getting started	8
3.1 Inserting & removing battery	8
3.1.1 Inserting battery.....	8
3.1.2 Removing battery	8
3.2 Notes on the battery.....	9
3.3 Capture thermal image.....	10
3.4 USB	10
3.4.1 USB connection.....	10
3.4.2 USB operation	10
3.4.3 USB Exit.....	10
4. Operation guide	11
4.1 Start-up interface.....	11
4.2 Operation interface.....	11
4.2.1 Interface introduction	11
4.2.2 Menu interface.....	13
4.2.2.1 Main menu.....	13
4.2.2.2 Setup Menu.....	14
4.2.2.4 UNCSet Menu	15
4.2.2.5 Dead pixel correction and UT reset menu	15
4.2.2.6 OLED Menu	16
4.2.3 Menu guide	17
4.2.4 Video Function Instruction	17
4.2.4.1 Operation procedure.....	17
4.2.4.2 Interface description	19
5 Technical specifications	20
6 Troubleshooting	22

1. Accessories

- Thermal image camera
- Transport case
- Lithium battery (3)
- Battery charger
- Power cable
- Power adapter
- Video power cable
- USB cable
- RS422 cable
- Bracket
- Communication protocol manual
- Operator's manual

2. Camera Overview

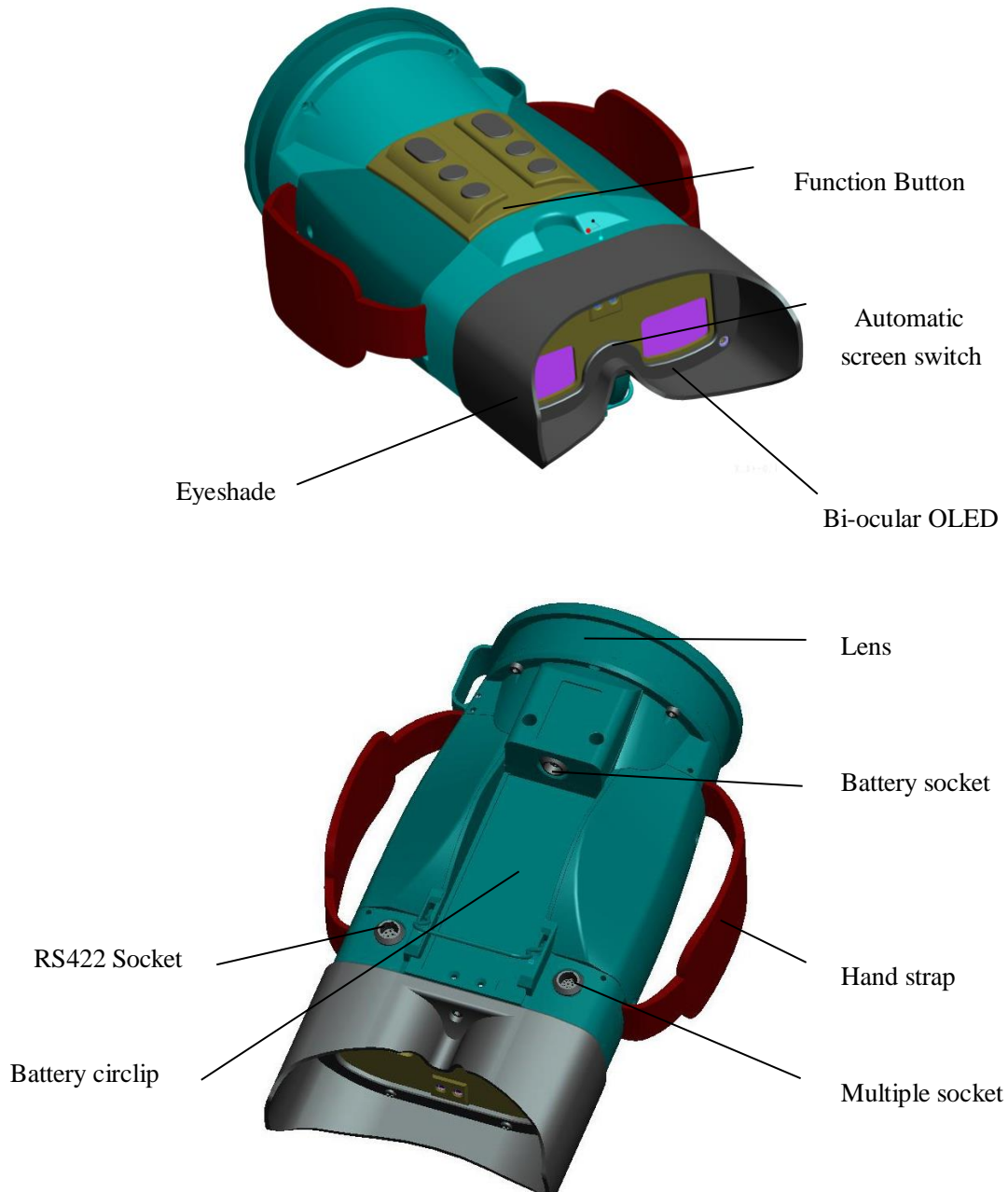

Figure.2.1 Overview of the camera

2.1 Function Button

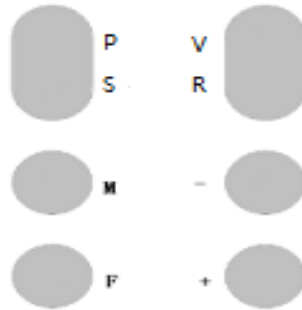

Figure.2.1.1 Schematic of function keys

◆ Menu & Power button (M).

Long press **M** ($\geq 3s$) to power on or power off.

Short press **M** in real-time mode to activate the main menu;

Short press **M** in main menu mode to choose menu option cyclicly.

◆ Calibration/Cancel button (F)

In real-time mode, long press **F** ($\geq 3s$) to do manual calibration;

In main menu mode, short press **F** to exit the main menu;

Note: if the image is not clear after start-up or long-time working, please long press **F** key ($\geq 3s$) to make calibration manually.

◆ + button (+)

In real-time mode, long press ($\geq 3s$) to manually adjust the lens to focus forwards; short press to manually adjust the lens to focus forwards by single-step; in menu mode, press + button to confirm the menu option or increase the option values.

◆ - button (-)

In real-time mode, long press ($\geq 3s$) to manually adjust the lens to focus backwards; short press to manually adjust the lens to focus backwards by single-step; in menu mode, press – button to confirm the menu option or decrease the option values.

◆ **P button(P)**

In real-time mode, short press **P** to take a photo; in replay mode, short press **P** to return to the previous menu. In video replaying, Short press **P** to pause the playing, and short press **P** again to exit the replaying.

◆ **V button(V)**

In real-time mode, short press **V** to take a video; When in video taking process, short press **V** to stop and save the video automatically; in replay mode, short press **V** to run the selected menu option.

◆ **S button(S)**

In files listed mode, short press **S** to select the previous file; in delete menu, press **S** to select the required option cyclicly.

◆ **R button(R)**

Short press **R** to replay the captured video and photos. When the files are listed, short press **R** to select the next file or select all files cyclicly. When a file is selected, long press **R** to activate the **Delete options interface**. When the images are replayed, short press **R** to activate/deactivate the slide replaying function.

2.2 Input & output connectors

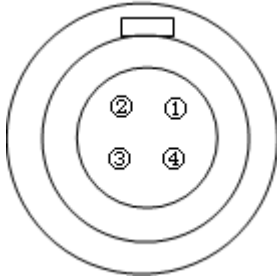

Figure.2.2.1 RS422 socket

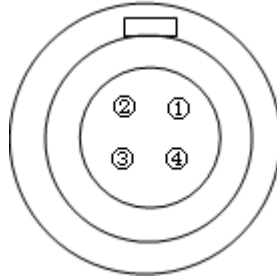

Figure.2.2.2 Battery socket

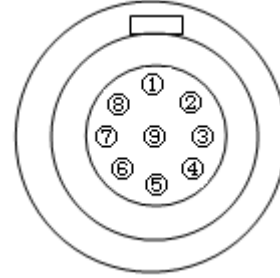

Figure.2.2.3 Multiple socket

[1] RS422 socket

Pin	Description
1	R (-)
2	R (+)
3	T (-)
4	T (+)

[2] Battery socket

Pin	Description
1	GND
2	BATIN
3	
4	

[3] Multiple socket

Pin	Description
1	CV1
2	VGND
3	PWR_SW
4	NULL
5	+12V
6	GND
7	IO PLUG
8	USB D+
9	USB D-

3. Getting started

3.1 Inserting & removing battery

3.1.1 Inserting battery



Figure.3.1.1.1 Inserting battery

- Put battery into battery slot.
- Push the battery till the end along with the battery socket direction.
- Connect the battery circlip with the battery lock.

Caution: only standard battery can be used, or battery may be stuck, and apparatus may be damaged by incorrect voltage and so on.

3.1.2 Removing battery

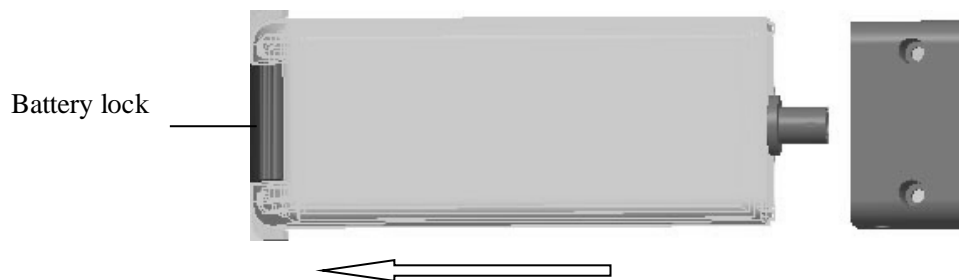

Figure.3.1.2.1 Removing battery

- Open the battery lock and loose the battery circlip.
- Pull up the battery circlip.
- Take the battery from the battery slot.

3.2 Notes on the battery

The standard battery is Polymer lithium battery. Even if there is still electricity left in battery, it has no effect while charging. Besides, please use the specified charger. If charge, push the battery into charger along with the battery track, and connect battery and charger. When battery and charger are connected, the LCD will display how much (%) electricity left in battery.

When charger is connected to power source, charging is started. On top right corner of LCD will indicate charging status and it will twinkle. When battery electricity displays 100%, it means the battery is full.

Note:

- **Take off the battery from the charger when charging is finished or is not needed.**
- **Please remove the battery from the apparatus without using the apparatus for a long time**
- ***Using battery must follow:***
 - Charge the battery before using or long-time conserving.
 - Only use the specified charger.
 - Do not make positive and negative ends short connected. Do not make metal touch the battery port. If short circuit takes place, the protect circuit inside the battery will start up. Charge the battery immediately to recover the battery.
 - Keep batteries far from fire source.
 - Never expose the battery in the temperature higher than 60°C
 - Keep batteries dry.
 - Never disassembly or refit batteries.

3.3 Capture thermal image

- Install the battery or connect the power cable (pay attention to the power polarity and voltage). Connect the video output device or directly observe via inner OLED binocular display.
- Long press “**M**” **button** to power on the camera. After startup interface is finished, the apparatus starts working and displays thermal image.
- Remove the lens cover and aim to the target. Press “**+**” **button** and “**-**” **button** at the same time to automatically focus on the target. Besides, short or long press “**+**” **button** or “**-**” **button** without menu to adjust focus in a single direction so as to capture the best thermal image.
- Adjust each menu function to optimize thermal image.
- When detecting target, if the image is not uniformly distributed, long press “**F**” **button** to revise the image in order to capture the optimal thermal image.
- When menu display is off, short press “**F**” **button** is to save the image or you can save it via file menu.

Note: Only after 10 seconds when image saving is completely finished, you can power off the camera.

3.4 USB

3.4.1 USB connection

Insert one end of USB cable into external power input end and connect another end of USB cable to PC.

3.4.2 USB operation

Power on the camera, PC will prompt founding the new hardware and it can be used. Meanwhile, there is a new “Removable disc (Disc drive)” in “My PC”, namely image storage space in the camera. Then you can do Save, Change and Delete operations to the images in the camera.

Note: while USB operation is in processing, you can not do Save, Delete and other operations using function keys in the camera, or the image may be lost.

3.4.3 USB Exit

Power off the camera directly and then remove the USB cable. Or you can exit USB operation using  under the PC right bottom corner.

4. Operation guide

4.1 Start-up interface

Make sure the system connection is correct. Long press power button “M” to power on the camera. After 3~5 seconds, the below start-up display will appear. Once process bar is finished, it will get into operation interface.

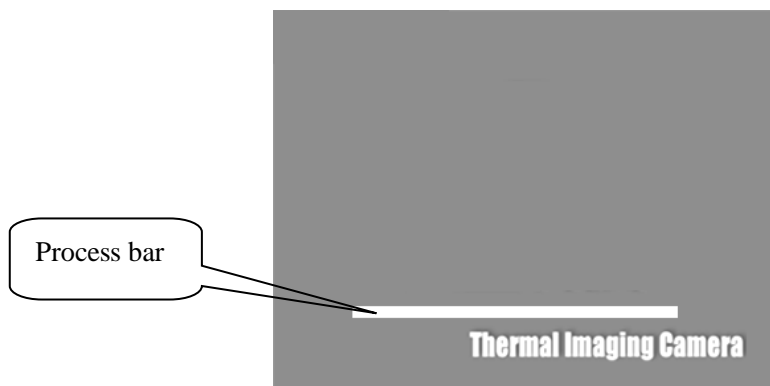

Figure.4.1.1 Start-up interface

Note: process bar indicates the whole time spent to start the camera and the current spent time.

4.2 Operation interface

4.2.1 Interface introduction

When stable image is displayed, the below interface will come out:

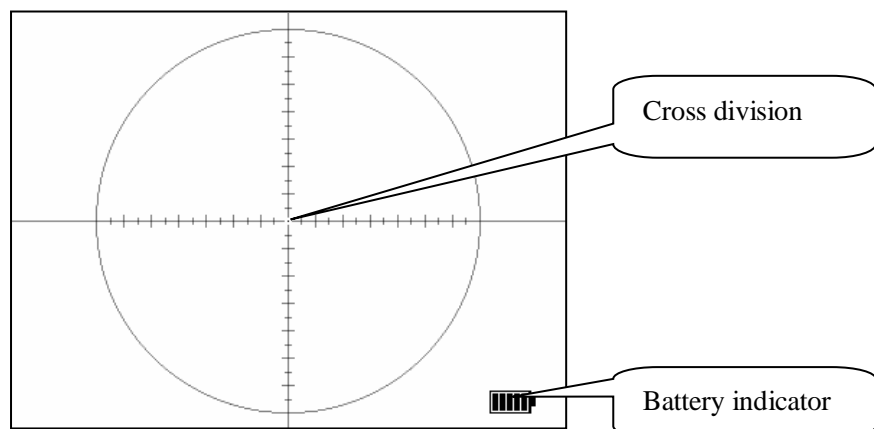

Figure.4.2.1.1 Operation interface

Cross division: Indicates target’s location. Division graduation is described as below **Figure. 4.2.1.2**. Menu decides whether it needs to display cross division or not.

Battery indicator: Indicates the current battery situation.



Indicates battery is full.



Indicates battery is very low. Need to charge.

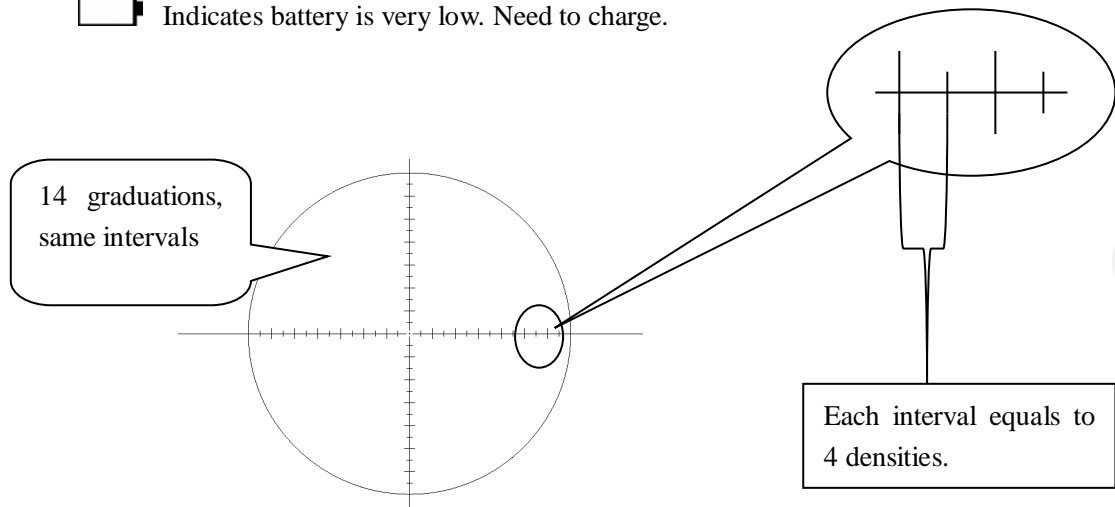

Figure.4.2.1.2 Division graduation

User can estimate the distance from the target according to the division graduation.

Estimation solution: if target is one-meter long, distance is 250 meters, when cursor is enabled, it will display one graduation in image. And so on.

4.2.2 Menu interface

4.2.2.1 Main menu

Press button “M” to enter into the below main menu interface:

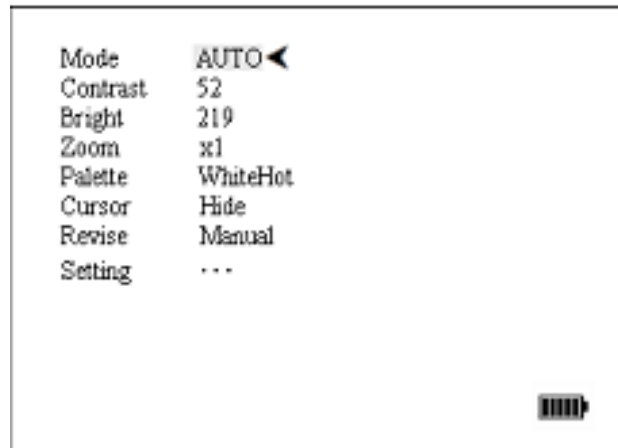

Figure.4.2.2.1.1 Main menu interface

- Mode:** Set current image mode as Auto or Manual.
Manual: Bright and Contrast need to be set manually.
Auto: Bright and Contrast can be automatically detected and confirmed.
- Contrast:** Set contrast and the range is 0~255. Only valid in manual mode
- Bright:** Set bright and the range is -2048~+2048. Only valid in manual mode.
- Zoom:** Set electronic magnification. Two options: x1: No zoom; x2: Numerical 2x.
- Palette:** Set the display mode as white-hot or black hot.
- Cursor:** Set division graduation as disabled (hide) or enabled (show).
- Revise:** Set revise mode as Manual or Auto.
- Setting: ...** Start menu of setting system parameters.

4.2.2.2 Setup Menu

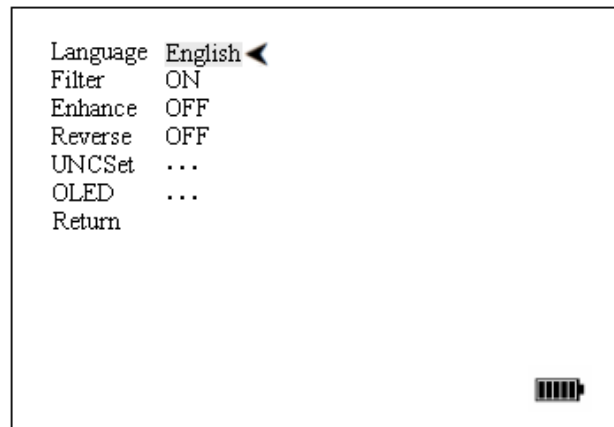

Figure.4.2.2.3.1 Setting menu interface

Language

Set system language.

Filter:

Set filter function as enabled (ON) or disabled (OFF).

Enhance

Set image enhance function as enabled (ON) or disabled (OFF).

Reverse

Set display property of division cursor. If selecting “ON”, it indicates that the division cursor can be anti-clockwise displayed according to gray grade of the image. Only valid when **Cursor** is set to ON.

UNCSet: ...

It is used to enable or disable the unset function.

OLED: ...

It is used for setting the OLED function.

Return

Return to previous menu.

4.2.2.4 UNCSet Menu

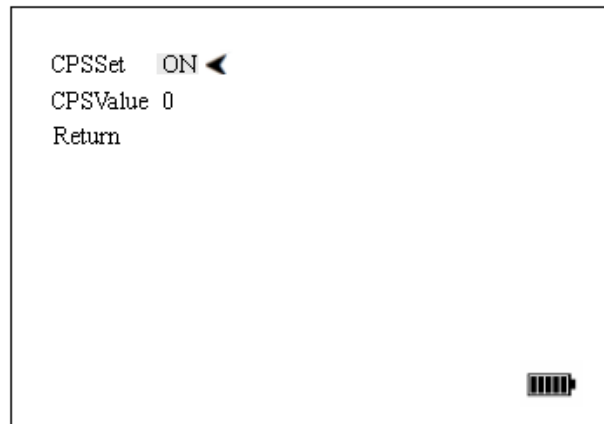

15

Figure.4.2.2.4.1 Compensation menu interface

CPSSET:

Set compensation function as enabled (ON) or disabled (OFF).

CPSVavalue

Set current compensation offset value. The range is -999~999.

(Only valid when **CPSSET** is ON)

Return

Return to previous menu.

4.2.2.5 Dead pixel correction and UT reset menu

When UNCSet menu interface is displayed (see **Figure.4.2.2.4.1**), long press **F button** ($\geq 5s$) to enter in dead pixel correction and used time reset menu as below.

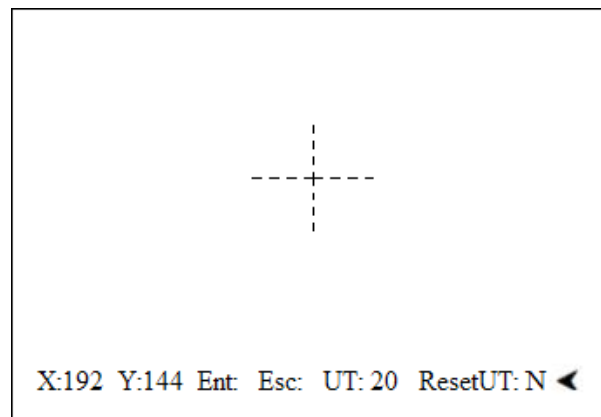

Figure.4.2.2.5.1 Dead pixel correction and UT reset menu

X :192

Location of crosshair in X direction

Y:144

Location of crosshair in Y direction

Ent:

Save dead pixel correction parameter and exit the menu;

<u>Esc:</u>	Exit dead pixel correction menu without saving change.
<u>UT:20</u>	Used time.
<u>Reset UT:</u>	Reset used time. Press M button to select the option <u>Reset UT:</u> and press + or – button to set it as Y . Then press F button to reset used time (<u>UT:</u> value will change to 0). When used time is reset, press M button to select option <u>Esc:</u> and press + or – button to exit the menu.

Note:

Once UT is reset, you must reboot the camera. When the dead point is selected, press F button to correct the dead pixel.

4.2.2.6 OLED Menu

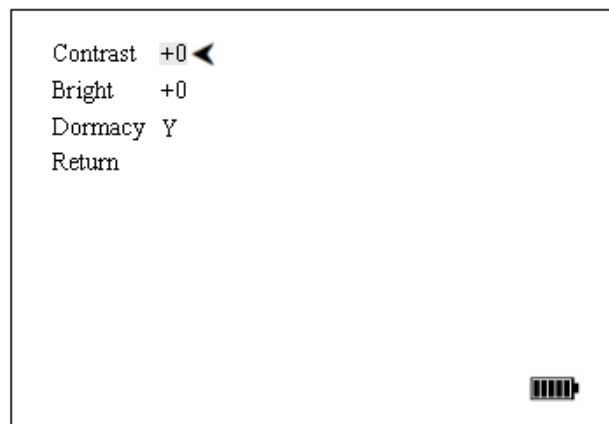

Figure.4.2.2.6.1 OLED menu interface

<u>Contrast:</u>	Adjust OLED contrast value.
<u>Bright:</u>	Adjust OLED bright value.
<u>Dormacy:</u>	Set OLED powers save on or not.
<u>Return</u>	Return to previous menu.

4.2.3 Menu guide

When menu display is off, press button “**M**” once is to activate main menu. The default menu is “Mode” menu. Press “**M**” key again, and the menu activation symbol “◀” will move down to and activate next menu option; Use “+” key or “-” key to choose function or increase or decrease values or enter to the sub-menu.

Menu option can be chosen in a cycle until the adjustment is finished. Choose “**Return**” or press “**F**” key to exit the menu edition. The adjusted parameter will be saved.

4.2.4 Video Function Instruction

4.2.4.1 Operation procedure

- **Take a photo**

When in real-time mode, short press button **P** to take a photo. It will display xxxx/xxxx at the top left corner. The digits before / indicate the current file number and the digits behind / indicate the rest number of images the TF card can take.

Note: each time press **P**, it can only take one photo. After saving, it will return to real-time mode. Photo is in JPG format.

- **Take a video**

When in real-time mode, short press button **V** to take a video. It will display xx: xx: xx/xx: xx: xx. The digits before / indicate the current video length by hour:minute:second and the digits behind / indicate the rest video length the TF card can take by hour:minute:second. To stop video taking, short press **V** and it will save the video automatically.

Note: each time press **V**, it can only take one video. After saving, it will return to real-time mode. Video is in AVI format.

- **Replay the photo and video**

When in real-time mode, short press **R** to activate the replay mode. It will display the **Replay interface** and list the save folder "100COACH". Short press **V** to open the 100COACH and it will list the saved files (both photos and video files). Short press **R** to select the file downwards

or short press **S** to select the file upwards and then press **V** to play.

Note:

- Video files are listed after the photos.
- To replay the photo, press **R** or **S** to select one photo and press **V** to play. When the selected photo is playing, press **R** to activate the "slide on" function to play automatically. Press **R** again to deactivate the slide function (slide off will be showed). Besides, press **S** to display the next photo.
- To replay the video, press **R** or **S** to select one video and press **V** to play.

- **Delete the file**

When all files are listed in replay mode, press **R** or **S** to select one file and then long press **R** ($\geq 3s$) to activate the delete menu interface as below:

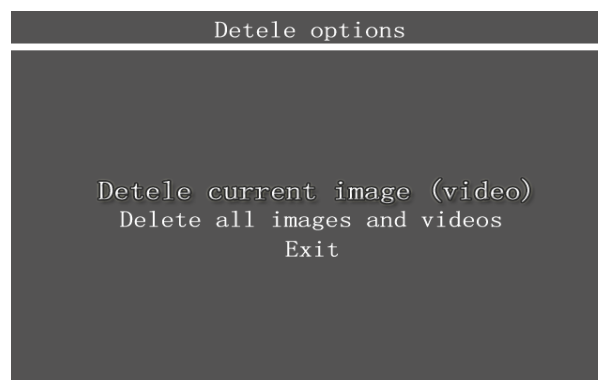

Press **S** to select the required option and press **V** to confirm the selection. For example, if "Delete current photo" is chosen and press **V**, it will come out a new interface as below:



Press **S** to select Yes and then press **V** to confirm the selection. Then the current selected photo will be deleted. After deleting, it will return to **Replay interface** (file list).

- **Exit the replay mode**

When in photo replay mode, short press **P** to return to **Replay interface** (file list). Press **P** again to return to 100COACH folder and press **P** again to return to real-time mode.

When in video replay mode, short press **P** to pause the playing and press **P** again to return to **Replay interface** (file list). Press **P** again to return to 100COACH folder and press **P** again to return to real-time mode.

When in delete menu interface, press **P** to return to **Replay interface** (file list) directly.

4.2.4.2 Interface description

- **Delete options interface**

When one file is selected, long press **R** ($\geq 3s$) to activate the Delete options menu as below.

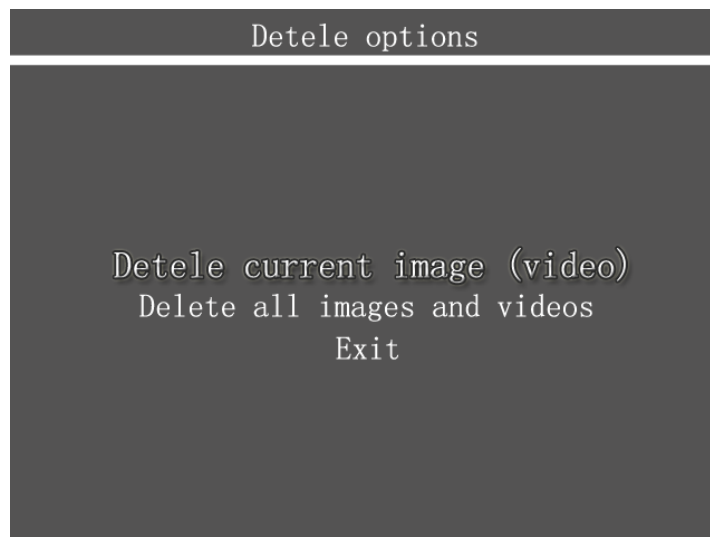

- **Replay interface**

In real-time mode, short press **R** to activate the Replay interface as below



5 Technical specifications

Items		<i>ThermalTronix TT-1730S-NVBM</i>
Detector	Type	Amorphous Silicon micro-bolometer
	Array format	384×288
	Pitch	35µm
Imaging performance	FOV	10.3°× 7.7 °±5%
	Min. focus distance	5m
	MRTD	≤0.5°C
	NETD	≤85mk@30°C
	Frame frequency	50HZ
	Focus	Automatic or manual
Display	Viewfinder	Bi-ocular OLED
Image functions	Brightness/gain adjust	Automatic or manual
	Color swap	Hot in white or in black
	Zoom	Numerical 2x
	Photo taking	√
	Video taking	√
Image storage	Type	Built-in flash memory(9Mb)
	File format	JPEG
	Video format	AVI
Power Source	Battery type	Li-Ion, rechargeable battery 7.4V/2200mAh
	External power	10-15V DC
	power consumption	≤4.5W (normal mode)

Environmental	Operating temperature range	-30°C ~ +60°C
	Storage temperature range	-40°C ~ +65°C
Physical Characteristics	Weight	<1.54Kg (excluding battery)
	Color	Black
	Tripod mounting	Bracket with 4×M3
	Size (L×W×H)	213 ×127 ×114mm (excluding eyeshade)
	Encapsulation	IP67
Interface & connectors	Power input	Yes
	Video output	PAL
	USB	Yes
	RS422	Yes

6 Troubleshooting

Please follow the below table to diagnose and solve the problem. If problem is still existed, please contact our service department.

Problem	Possible reason & Solution
The camera does not power on.	<ul style="list-style-type: none"> ● Battery not installed or installed incorrectly →Install battery or re-install battery ● Battery is out of power. →Change battery. ● “Power off” protection is enabled →Wait for 5 seconds and reboot. ● Operation Over environmental temperature range
The camera power off automatically.	<ul style="list-style-type: none"> ● Battery is out of power. →Change battery
Battery depletion is too fast	<ul style="list-style-type: none"> ● Environment temperature is too low ● Rechargeable battery is not charged completely. →Recharge the battery. ● Rechargeable battery is out of power completely and can not be recharged. →Change new battery.
No thermal image	<ul style="list-style-type: none"> ● Lens cover is not removed. →Remove lens cover. ● In image browsing status →Return to real-time observe status.
Can't recall previously saved images	<ul style="list-style-type: none"> ● Too fast in save image →Delete image
Image long-time paused when browsing	<ul style="list-style-type: none"> ● Reboot after formatting