

**IT-IPS-618-IM**  
**8-Ports Fast Ethernet**  
**Industrial PoE Switch User Manual**

### 【Summarize】

IT-IPS-618-IM is an industrial grade, managed and redundancy PoE Ethernet switch. The industrial PoE switch consists of 8 ports Fast Ethernet. Fast Ethernet port support Fast Ethernet copper ports and optical fiber port option. The PoE port support IEEE802.3af/at standard, single-port maximum 30W power supply. It provided some kinds of advanced network managed function, like as: Ring redundancy ring network, VLAN, Trunking, Quality of Service, Speed control, port mirroring and fault alarm. Ring can bring your Ethernet to intelligent redundancy. The -40~75°C working temperature, can meet all kinds of industrial environment requirement and provide the solution of the economy.

### 【Packing list】

The industrial PoE switch is shipped with the following items. If any of these items are missing or damaged, please contact your customer service representative for assistance.

- Industrial PoE switch ×1
- User manual ×1
- DIN-Rail mounting kit ×1

### 【Features】

- Support IEEE802.3, IEEE802.3u, IEEE802.3x, IEEE802.1Q, IEEE802.1p, IEEE802.1D, IEEE802.1W
- Support IEEE802.3af standard, full-port (PoE) full 15.4W power supply
- Support IEEE802.3at standard, single-port maximum 30W power supply.
- Ring network patent technology (Fault recovery time<20ms)
- Support RSTP, way exchange time<50ms
- Support static multicast, IGMP Snooping and GMRP
- Support Port based VLAN and IEEE 802.1Q VLAN
- Support QOS absolutely and opposite priority
- Support WEB, SNMP and Telnet configuration
- Support port status display, data update.
- Industrial grade design, -40-75°C work temperature
- IP40 protection grade, DIN rail mounted

## 【Panel layout】

Vertical view and bottom view

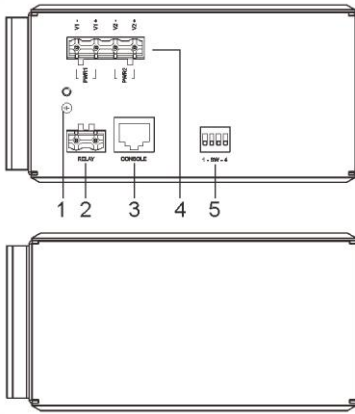

Rear view

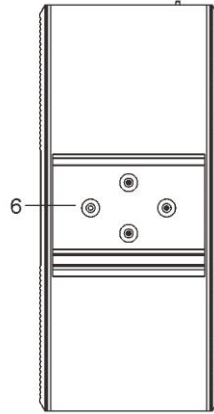

8-ports 10/100Base-T(x) PoE

4-ports 10/100Base-T(x) PoE + 4-port 10/100Base-T(x)

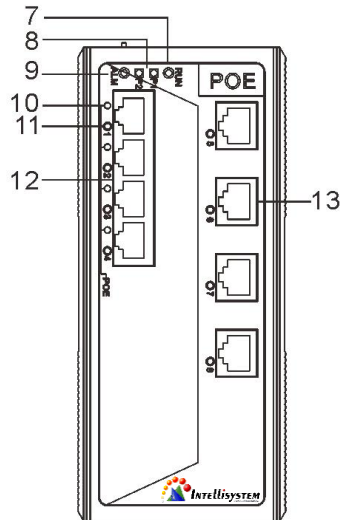
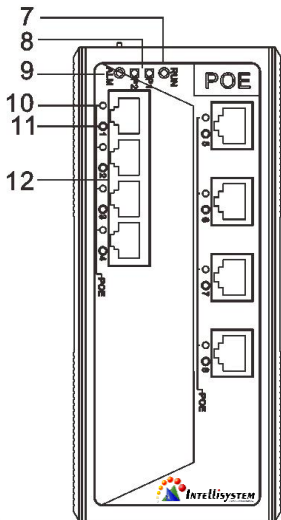

4-port 10/100Base-T(x) PoE + 2-port 10/100Base-T(x) + 2-port 100Base-FX

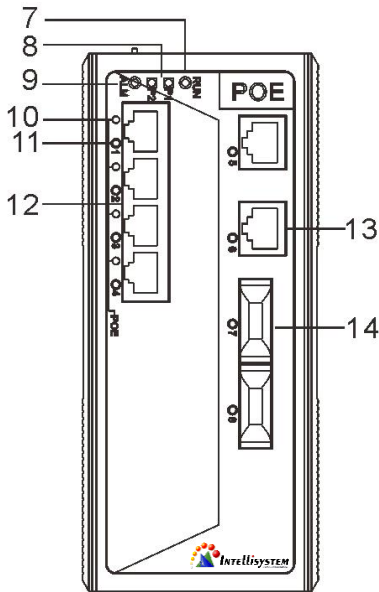

1. Ground screw
2. Terminal block for relay output
3. Console port
4. Terminal block for power input (PWR1, PWR2)
5. DIP switches
6. DIN-Rail mounting kit
7. System running indicator
8. Power input P1 (P2) LED
9. Relay alarm indicator
10. PoE port Link/ACT indicator
11. Ethernet port Link/ACT indicator
12. 10/100M Base-T(x) PoE port
13. 10/100M Base-T(x) port
14. 100M Base-FX port

### 【Power supply input】

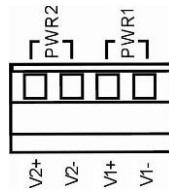

The product top panel provided 4 bit power supply input terminal block, support DC input. DC power supply input supported redundancy function, provided PWR1 and PWR2 power input, can use for single, and can connect 2 separately power supply system, use 1 pair terminal block connect the device at the same time. If one of the power systems broke, the device can work un-interruptible. Built-in overcorrect protection, Reverse connection protection. Voltage input range is 48VDC (terminal block defined as: V1-, V1+, V2-, V2+). The power support is not polarity that the device can still work normally after the reverse.

### 【Dimensions】

The series of products size is the same, and the type of the Ethernet interface is different. Unit (mm)

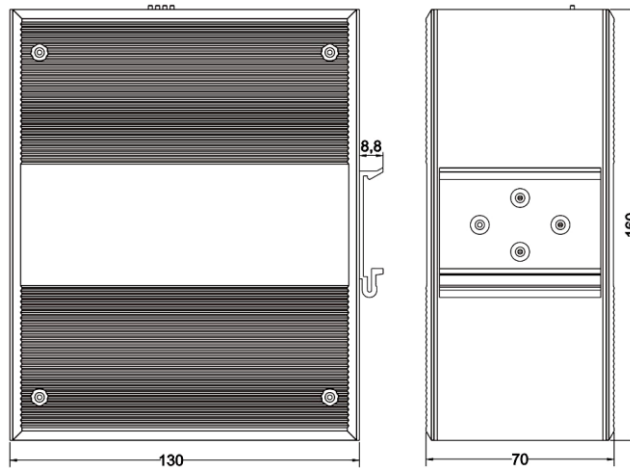

### 【Relay connection】

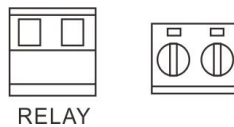

Relay access terminals in the top panel of the device. Between the two terminal relay, as an open circuit state in normal non alarm state, when there is power alarm information to the closed state. The two terminal block connector are used to detect power failure and network anomaly. The two wires attached to the Fault contacts form a closed circuit when the device port connection disconnect or has lost power supply from one of the DC power inputs. The user can connect the relay to the lamp indicate or buzzer alarm to remind the relevant staff.

### 【Console port】

This series product provided 1pcs procedure test port based in serial port. It adopts RJ45 interface, located in top panel, can configure related command through RJ45 to DB9 female cable.

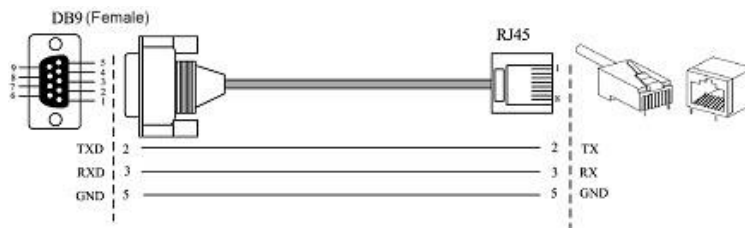

### 【DIP Switch】



Top panel provided 4 bits DIP switch to do function configure (ON to enable effective), 1 and 4 keep for future function. 2 is recovery default factory. 3 is for upgrade. Please power off and power on when you change the status of DIP switch.

## 【Communication connector】

### 10/100BaseT(X) Ethernet port

The pinout define of RJ45 port display as below, connect by UTP or STP. The connect distance is no more than 100m. 100Mbps is used 120Ω of UTP 5, 10Mbps is used 120Ω of UTP 3, 4, 5.

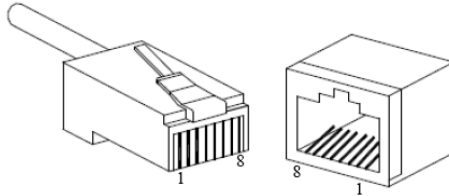

RJ45 port support automatic MDI/MDI-X operation. Can connect the PC, Server, Converter and HUB .Pin 1,2,3,6 Corresponding connection in MDI. 1→3, 2→6, 3→1, 6→2 are used as cross wiring in the MDI-X port of Converter and HUB. 10Base-T/100Base-TX are used in MDI/MDI-X, the define of Pin in the table as below.

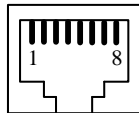

NO.	MDI signal	MDI-X signal
1	TX+	RX+
2	TX-	RX-
3	RX+	TX+
6	RX-	TX-
4, 5, 7, 8	—	—

Note: “TX±” Transmit Data±, “RX±” Receive Data±, “—” Not use.

### 10/100Base-T(X) MDI (straight-through cable)

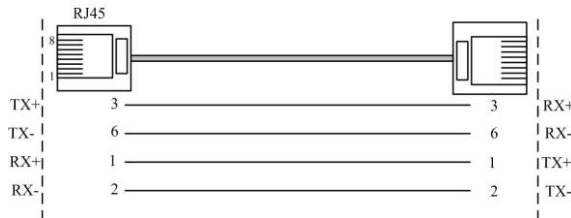

### 10/100Base-T(X) MDI-X (Cross over cable)

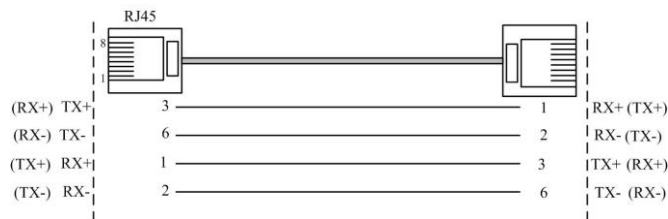

MDI/MDI-X auto connection makes switch easy to use for customers without considering the type of network cable.

### 100Base-FX Fiber port

100Base-FX full-duplex SM or MM port, SC/ST/FC type .The fiber port must be used in pair, TX (transmit) port connect remote switch's RX(receive) port; RX(receive) port connect remote switch's TX(transmit) port.

The optical fiber connection supports the line to instruct enhance the reliability of network effectively.

**Suppose:** If you make your own cable, we suggest labeling the two sides of the same line with the same letter (A-to-A and B-to-B, shown as below, or A1-to-A2 and B1-to-B2).

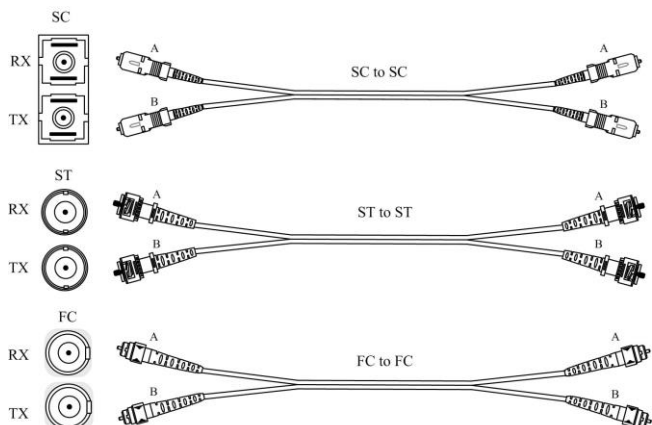

### 【LED Indicators】

LED indicator light on the front panel of product, the function of each LED is described in the table as below.

System indication LED		
LED	State	Description
<b>PWR</b> (1~2)	ON	Power is being supplied to power input PWR input
	OFF	Power is not being supplied to power input PWR input
<b>RUN</b>	ON/OFF	System is not running well
	Blinking	System is running well
<b>Alarm</b>	ON	When the alarm is enabled, power or the port's link is inactive.
	OFF	Power and the port's link is active, the alarm is disabled.
<b>Link/ACT</b> (1~8)	ON	Port connection is active
	OFF	Port connection is not active
	Blinking	Data transmitted
<b>POE</b> (1~4/1~8)	ON	The PoE device is connected by IEEE802.3af/at standard
	OFF	No PoE power output or no PoE connected PoE devices

### 【Installation】

Before installation, confirm that the work environment meet the installation require, including the power needs and abundant space. Whether it is close to the connection equipment and other equipments are prepared or not.

1. Avoid in the sunshine, keep away from the heat fountainhead or the area where in intense EMI.
2. Examine the cables and plugs that installation requirements.
3. Examine whether the cables be seemly or not (less than 100m) according to reasonable scheme.
4. Power: 48VDC (44~57VDC) power input
5. Environment: Working temperature: -40~75°C

Relative humidity: 5% ~ 95%

#### DIN Rail Installation

In order to use in industrial environments expediently, the product adopt 35mm DIN-Rail installation, the installation steps as below:

1. Examine the DIN-Rail attachment
2. Examine DIN Rail whether be firm and the position is suitability or not.

3. Insert the top of the DIN-Rail into the slot just below the stiff metal spring.
4. The DIN-Rail attachment unit will snap into place as shown below.

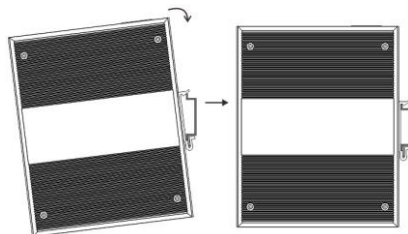

### Wiring Requirements

Cable laying need to meet the following requirements,

1. It is needed to check whether the type, quantity and specification of cable match the requirement before cable laying;
2. It is needed to check the cable is damaged or not, factory records and quality assurance booklet before cable laying;
3. The required cable specification, quantity, direction and laying position need to match construction requirements, and cable length depends on actual position;
4. All the cable cannot have break-down and terminal in the middle;
5. Cables should be straight in the hallways and turning;
6. Cable should be straight in the groove, and cannot beyond the groove in case of holding back the inlet and outlet holes. Cables should be banded and fixed when they are out of the groove;
7. User cable should be separated from the power lines. Cables, power lines and grounding lines cannot be overlapped and mixed when they are in the same groove road. When cable is too long, it cannot hold down other cable, but structure in the middle of alignment rack;
8. Pigtail cannot be tied and swerved as less as possible. Swerving radius cannot be too small (small swerving causes terrible loss of link). Its banding should be moderate, not too tight, and should be separated from other cables;
9. It should have corresponding simple signal at both sides of the cable for maintaining.

### 【Specifications】

#### Technology

Standard: Support IEEE802.3, IEEE802.3u, IEEE802.3x, IEEE802.1Q, IEEE802.1p, IEEE802.1D, IEEE802.1W

Protocol: ARP, ICMP, TCP, DHCP, DNS, HTTP, Ring, Telnet, RSTP, SNMP

Flow control: IEEE802.3x flow control, back press flow control

POE Standard: IEEE802.3af/at

#### Functions

Switch function: Ring, QOS, 802.1QVLAN, RSTP, SNMP, Port trunking, static multicast filter, port mirroring, bandwidth management, port flow statistics, upgrade online, up and download configuration file, user name access system

Ring: Support Single, Couple, Chain, Dual homing

#### Exchange attributes

100M forward speed: 148810pps

Transmit mode: store and forward

System exchange bandwidth: 7.6G

MAC address table: 8K

Memory: 1M



## Interfaces

Fast Ethernet Port: 10Base-T/100Base-TX auto speed control, Half/full duplex and MDI/MDI-X auto detect

100M optic fiber port: 100Base-FX, SC/ST/FC connector, support single mode (20/40/60/80Km optional), multi mode (2Km), wavelength: 1310nm, 1550nm

Console port: debug serial port carry out CLI command

Alarm port: 2 bit 7.62mm terminal block

1 channel relay alarm output

Current load capacity 1A@24VDC

PoE Pin-out: 1/2(+), 3/6(-)

## Transfer distance

Twisted cable: 100M (standard CAT5/CAT5e cable)

Multi-mode: 1310nm, 2Km

Single-mode: 1310nm, 20/40/60Km

1550nm, 80/100/120Km

## LED indicators

Run indicator: Run

Interface indicator: Link (1~8)

POE indicator: 1~4/1~8

Power supply indicator: P1, P2

Alarm indicator: Alarm

## Power supply

Input Voltage: 48VDC (44~57VDC)

Type of input: 4 bits 7.62mm terminal block

Support over-current protection: 4.0A (DC)

Support redundant power, reverse connection protection

## Consumption

◇ 8-port 10/100Base-T(x) PoE

No-load consumption: 6.5W@48VDC

Full-load consumption: 132W@48VDC

◇ 4-port 10/100Base-T(x) PoE + 4-port 10/100Base-T(x)

No-load consumption: 6.5W@48VDC

Full-load consumption: 77.2W@48VDC

◇ 4-port 10/100Base-T(x) PoE + 2-port 10/100Base-T(x) + 2-port 100Base-FX

No-load consumption: 9.4W@48VDC

Full-load consumption: 80.5W@48VDC

Single PoE port maximum consumption: 30W@48VDC

## Working environment

Working temperature: -40~75°C

Storage temperature: -40~85°C

Relative Humidity: 5%~95% (no condensation)

**Mechanical Structure**

Shell: IP40 protect grade, metal shell

Installation: DIN-Rail mounting

Size (W×H×D): 70mm×160mm×130mm

Weight: 0.95kg

**Industry Standards**

EMI: FCC Part 15, CISPR (EN55022) class A

EMS: EN61000-4-2 (ESD), Level 4

EN61000-4-4 (EFT), Level 4

EN61000-4-5 (Surge), Level 4

Shock: IEC 60068-2-27

Free fall: IEC 60068-2-32

Vibration: IEC 60068-2-6

**Certifications**

CE, FCC, RoHS, UL508 (Pending)

**Warranty:** 5 years