

IT-SS04D-IR

With 4 high power Infrared LEDs for a total power consumption of 10W, beam angle 15° to 120°, beam distance 70m to 10m, the IT-SS04D-IR is an IR Illuminator with a high service of life.

- Wavelength 740nm/850nm/940nm.
- 30,000 hours lifetime LEDs.
- Extended working temperature range -40 to 50°C.
- 1-3 years warranty.



Product Family

The IT-SS04D-IR is part of the high-power Professional IR Illuminators series that is the top quality Infrared LED light source solution for night-time illumination, providing high-power infrared light for CCTV and IP cameras to enhance night-time visual performance.

Professional Design

- Two stages of constant current circuit avoid LEDs away from instantly impulse impact when started.
- Low failure rate of products is guaranteed by the professional in-house optimized independent circuit technology, which has been widely used in our LED illuminators for more than 5 years.
- Wide edge of silica gel circle and water stop line ensure IP66 waterproof and dustproof level.
- Twice direct cooling heat sink processing enable to increase the cooling coefficient and prolong the service life of the product.
- Patent design hexagonal spherical light sensor more accurately responses ambient brightness and improves accuracy of automatic light control.
- Flexible angle adjustable bracket can extend the illuminance range widely.
- Robust cooling fin design permits the infrared illuminator to operate from -40°C to 50°C.
- Super energy saving circuit with low electrical power consumption.

Qualified Materials

- Super power dot-matrix infrared light LED with strong light effect, long service life and low light decline.
- High efficient twice optical lens processing achieves 90% of the luminous efficiency.
- The housing adopts high thermal conductivity aluminum to enhance heat dispersion property.
- Stainless steel bracket and screw ensure low maintenance.

Wide Range of Applications

Recommended for security at ports, railway systems, border, prisons, traffic LRP/ANPR, ITS, as well as large public places surveillance.

Basic Functions

- *To improve performance of the weak light camera, thereby enhancing the picture effects at night.*
- *Conventional night monitoring.*
- *The function of video analysis at night.*
- *Reduce signal noise and other image distortion.*
- *Reduce the network bandwidth requirements.*
- *Energy saving by power factor correction.*
- *Reduce the equipment cost.*
- *Lower cost of installing and wiring.*

Technical Specifications

LED type: 4 pieces 2W dot-matrix IR LEDs

Wavelength: 740nm/850nm/940nm

Voltage: AC85-265V/DC12V/AC24V

Power consumption: 10W (850nm)

Day & Night switch: Auto (build in photocell)

Cable length: 1.3m

Mounting: Wall mounting "U" bracket

Temperature: -40°C to 50°C

Grade of protection: IP66

Color: Beige

Housing: Aluminum

Panel: High light transmittance toughened glass

Net weight: 0.45 kg

Gross weight: 0.6 kg

Dimensions: 84*84*80mm

Packing dimensions: 180*155*120mm

Models for Selection

Model	Beam angle	Viewing IR distance
IT-SS04D-15-IR	15°	70m
IT-SS04D-30-IR	30°	50m
IT-SS04D-45-IR	45°	35m
IT-SS04D-60-IR	60°	20m
IT-SS04D-90-IR	90°	14m
IT-SS04D-120-IR	120°	10m

**Viewing IR distance is tested by Sony 1/3 CCD Camera and 850nm IR LEDs.*

To achieve the distance needed, please pay attention to your camera specifications and lens before purchase. It is normal phenomenon that distance may vary due to different cameras and lens.

Mechanical Drawings

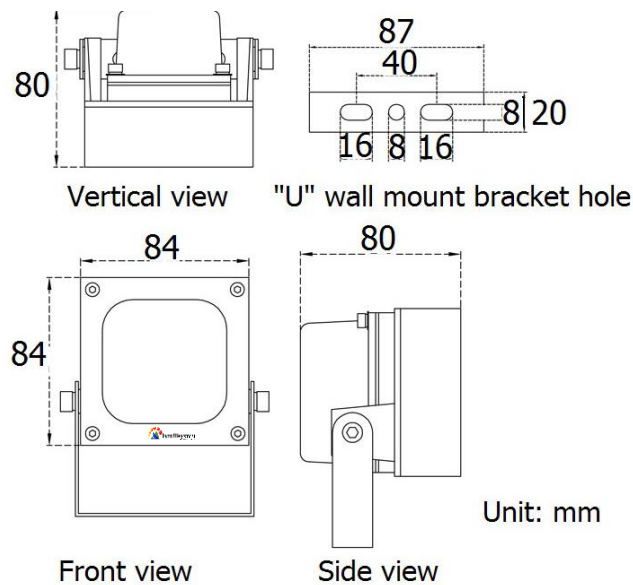

Viewing Picture at Night



With IR



Without IR