

IT-SSL300-IRL

Adopt with innovating homogenization laser technology, IT-SSL300-IRL has even IR light spot. Equipped with high power IR laser tube for 300m/500m IR distance and excellent quality of electric zooming lens of 1-60° adjustable angle, the product can be flexible installed for many kinds of occasions. With a standard interface parameters, it's compatible with the industry general protocol Pelco-D and Sony VISCA. In the process of beam angle adjustment, user can set the preset position for calling to control the beam angle of laser automatically to the set point of view. It is the ideal infrared lighting source for night vision CCTV/IP cameras.



Product Features

- Photoelectric conversion efficiency reach to 40%
- Smooth electric synchronous zoom from 1° to 60°
- Life span is 50,000hrs
- homogenized light spot with no noise
- RS485 interface
- Coaxial lens focus, sync. with camera
- Power lose memories
- Preset position
- Low heating, high efficiency

Application

- Forest Fire Prevention
- Oil well monitoring system
- Public security system
- Traffic speed measurement

Real Picture



Day



Night



IR OFF



IR ON

Technical Specification

Parameter	Parameter Value
Model	IT-SSL300-IRL
Laser Mode	Multi-mode
Wavelength	808±10nm
Optical Power	2W
Illumination Angle	1°-60° adjustable
Beam Shape	Round
Beam Diameter	5m diameter with 1° at 300m
Beam Spot Uniformity	Good
Viewing Distance	300m
Operating Voltage	DC12V
Operating Current	1.2A
Service Life	50000h
Operating Temperature	-40°C to +60°C
Storage Temperature	-40°C to +85°C
Power Consumption	<15W
Dimension	L156*W90*H159mm
Material	Aluminium Alloy
Color	Black color
Total weight	1.65kg
Laser Protection	1M

Dimension

Unit: mm

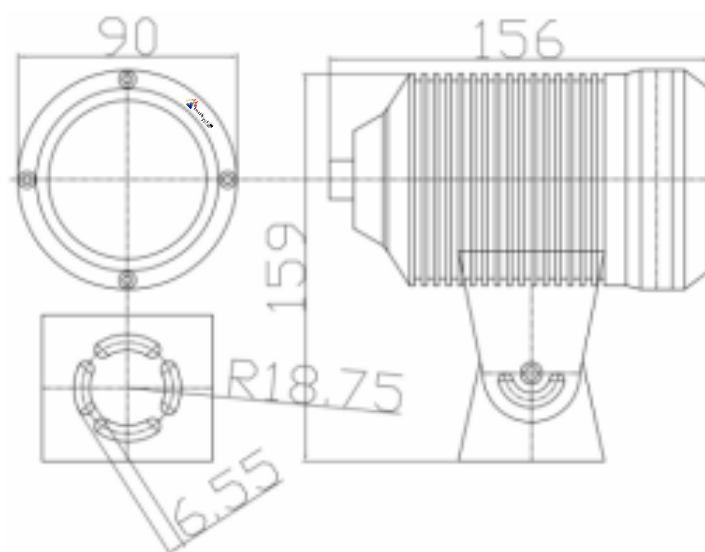

Interface Connection

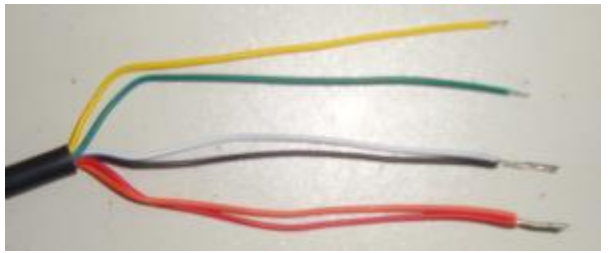
Power Line- Anode	Red & Orange DC12V+	
Power Line-Cathode	Black & White DC12V-	
Control Line A	Yellow RS485+	
Control Line B	Green RS485-	
Control Line- Cathode	White	
Communication Interface	RS485	

RS485 Interface Control Instructions

Speed dome keyboard control

Speed dome keyboard control & communication protocol: General Pelco-D

Speed Dome Keyboard	Function	Coding
254-SHOT-ACK	Laser Power On	81 01 04 00 02 FF
255-SHOT-ACK	Laser Power Off	81 01 04 00 03 FF
TELE	Zoom Up	81 01 04 07 27 FF
WIDE	Zoom Down	81 01 04 07 37 FF
	Zoom Off	81 01 04 07 00 FF
	Electrical Machine Speed Setup	81 01 05 P1 P2 FF (P1-High order, P2- Low order, Range ≤60000)



Speed Dome Keyboard

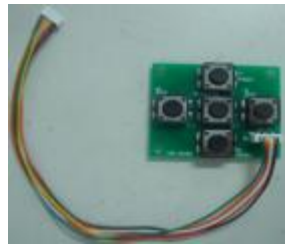

Tips: We suggest using Speed Dome Keyboard preferentially to control the IR laser light! In case you don't have one you can use the small keyboard we supplied!

Small keyboard Control

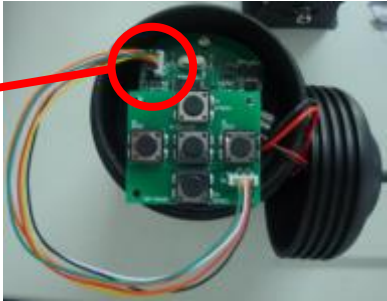
Button	Function	Small key board 
K1	Zoom Up	
K2	Zoom Down	
K3	Electrical Machine Speed Up	
K4	Laser On/ Off	
K5	Electrical Machine Speed Down	

<p>1. Twist out the rear cover when adjust the Keyboard.(Anti-clockwise Direction)</p> <p>*Main board Keyboard Cable Interface 1.25MM*6P</p>	
<p>2. After the adjustable of laser light adjustable, tighten the rear cover.</p>	

Laser Safety Instruction

Laser safety mark and requirements

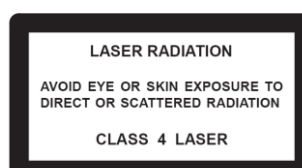



■ S-S300L laser class:

According to GB7247.1-2012 or IEC60825-1:2007 standard, the safety level of this product is Class 1. Output laser light with 800-1000nm, 1.5W power. This level of power is safety to human eye, the output radiation is invisible light.

- S-S300L IR laser light is a light sources, to be integrated with other equipment by user. The user will be responsible for the integrated products.
- S-S300L laser emission power is 1.5W including visible and invisible ray, wavelength is 800-1000nm.
- It is prohibited to move or re-install the output colimation under the laser light is power on.

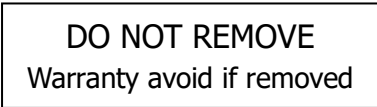
■ Laser warning mark

Mark	Instruction	Position
	If this warranty label is damaged / removed the product cannot be repaired.	On the upper cover of the case
	Laser radiation warning sign	On the upper cover of the case
	Warning label	On the upper cover or front cover of the case