

IT-WPS1

IP66 Waterproof outdoor installation power supply unit for LED Illuminators.

- Waterproof power supply unit with “U” bracket.
- Output DC12V 1000mA.



Technical Specifications

Input: AC110-220V

Frequency: 50-60HZ

Output: DC12V 1000mA

Output plug: DC12V male plug 

Install bracket: “U” bracket

Working temperature: -30°C to +50°C

Housing: Aluminum die-casting housing

Protection level: IP66

Color: Black

Net weight: 0.35 kg

Gross weight: 0.4 kg

Dimensions: 90*96*42mm

Packing dimensions: 130*100*100mm

Drawing and Dimensions

Unit: mm

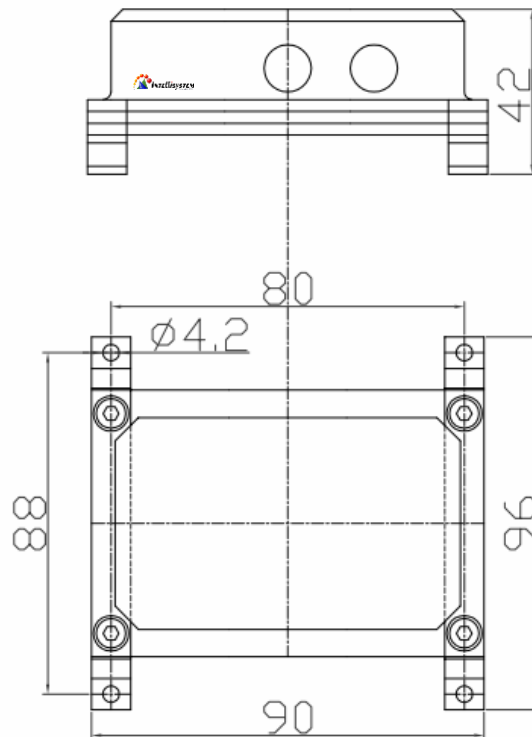

Operate Instructions

1. The junction of Input and output cable must be downward to avoid water in.
2. Input cable must be grounded, ensure lightning protection measures.
3. Don't use against any fire precaution rules during operation.
4. Install and adjust by professional electrician or quality technician.
5. Do not open the case and remove the power supply.